

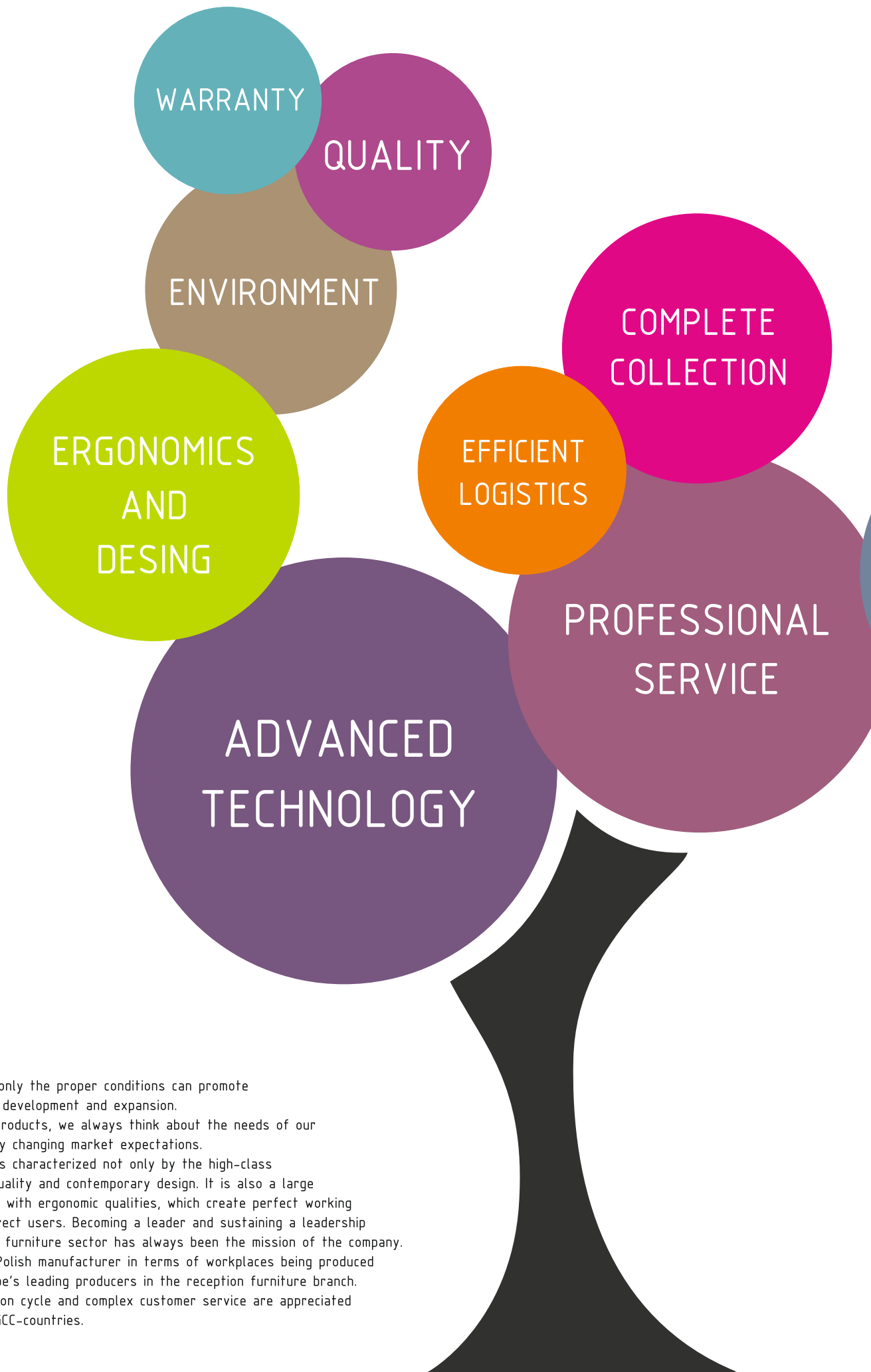

YAN_

 mdd



WARRANTY

QUALITY

ENVIRONMENT

ERGONOMICS
AND
DESING

ADVANCED
TECHNOLOGY

EFFICIENT
LOGISTICS

COMPLETE
COLLECTION

PROFESSIONAL
SERVICE

It is well known that only the proper conditions can promote significant creations, development and expansion.

While designing our products, we always think about the needs of our clients and constantly changing market expectations.

Furniture from MDD is characterized not only by the high-class technology, superb quality and contemporary design. It is also a large diversity of products with ergonomic qualities, which create perfect working conditions for the direct users. Becoming a leader and sustaining a leadership position in the office furniture sector has always been the mission of the company. We are the biggest Polish manufacturer in terms of workplaces being produced and one of the Europe's leading producers in the reception furniture branch. Our effective operation cycle and complex customer service are appreciated in Europe, USA and GCC-countries.

COMPETITIVE
PRICE

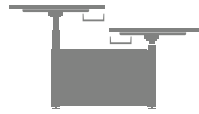

DRIVE 4-7



YAN_Z 8-15



YAN_T 16-23



YAN_M 24-31



YAN_C 32-39



CONFERENCE TABLES 40-41



PANELS 42-45



CABLE MANAGEMENT 50-51



SAVA_GAYA 52-53

DRIVE

DRIVE bench gives the opportunity of quick and easy adjusting to individual needs without compromising on functionality and space. Each work counter has its own individual mechanism which works independently. DRIVE bench can be equipped with fabric panels to divide a work surface for more privacy. Dividing the work surface does not, in any way, reduce the access to the horizontal cable management underneath the work top.

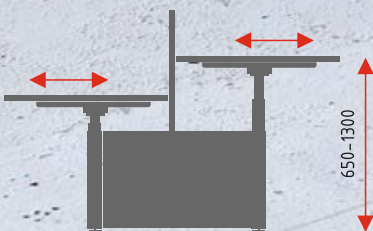

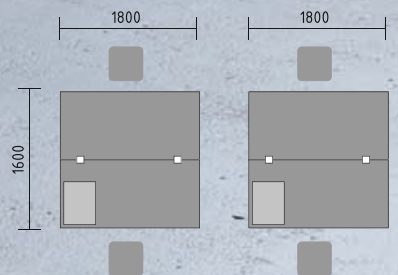

- CTA50 X 2 BENCH WITH ELECTRIC HEIGHT ADJUSTMENT 1800/1690/650-1300
- ZD818 X 2 FABRIC PANEL 1794/38/800
- A5504 STORAGE 801/432/1833
- A5404WZ STORAGE WITH GLASS DOOR 801/432/1833
- A5104HZ STORAGE WITH HPL FRONT 801/432/1833
- SLD13 X 2 PEDESTAL 402/600/586
- SAVA X 2 CHAIR 660/610/1050-1150

DRIVE

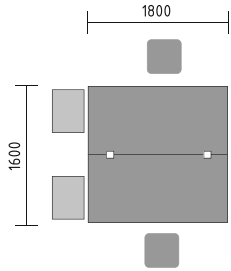

CTA05 X 2 STRAIGHT DESK WITH ELECTRIC HEIGHT ADJUSTMENT 1800/800/650/1300
 ZM618 FABRIC PANEL FOR SINGLE DESK 1800/38/650
 ZN13 X 4 DIVISORY FABRIC SIDE PANEL 800/38/650
 IKDT13 X 3 PEDESTAL 402/600/586
 A2L06 X 4 TAMBOUR STORAGE 1200/432/740
 S94 X 2 VERTICAL CABLE DUCTIN Ø140/750-1200
 SAVA CHAIR 660/610/1050-1150

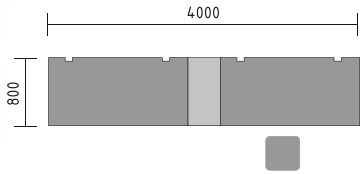

CTA04 X 2 STRAIGHT DESK WITH ELECTRIC HEIGHT ADJUSTMENT 1600/800/650/1300
 ZM616 X 2 FABRIC PANEL FOR SINGLE DESK 1600/38/650
 S94 X 2 VERTICAL CABLE DUCTIN Ø140/750-1200
 IKCD80 CARGO PEDESTAL 402/800/1100
 IKDT12 PEDESTAL 402/600/586
 SAVA CHAIR 660/610/1050-1150

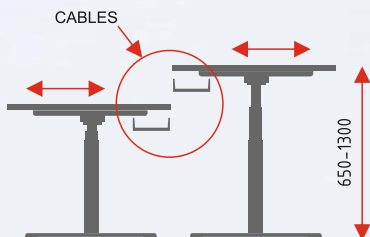

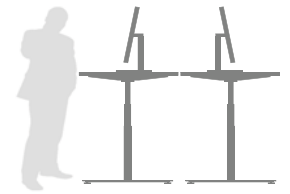
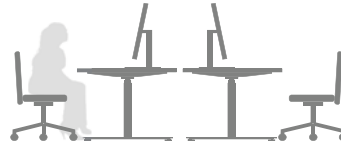
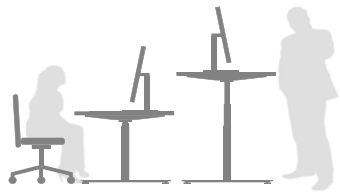

DRIVE is an electric height regulation desks which allows for customized standing and sitting positions and is a great ergonomically solution. The electrical height regulator, located underneath the work surface, simplifies changes in positions depending on one's office needs. Changing position during long working hours increases work effectiveness, productivity and health. To create an intimate climate, DRIVE allows you to add acoustic panels. There are two types of acoustic panels which fit perfectly both horizontally and vertically to the worktop.



YAN_Z



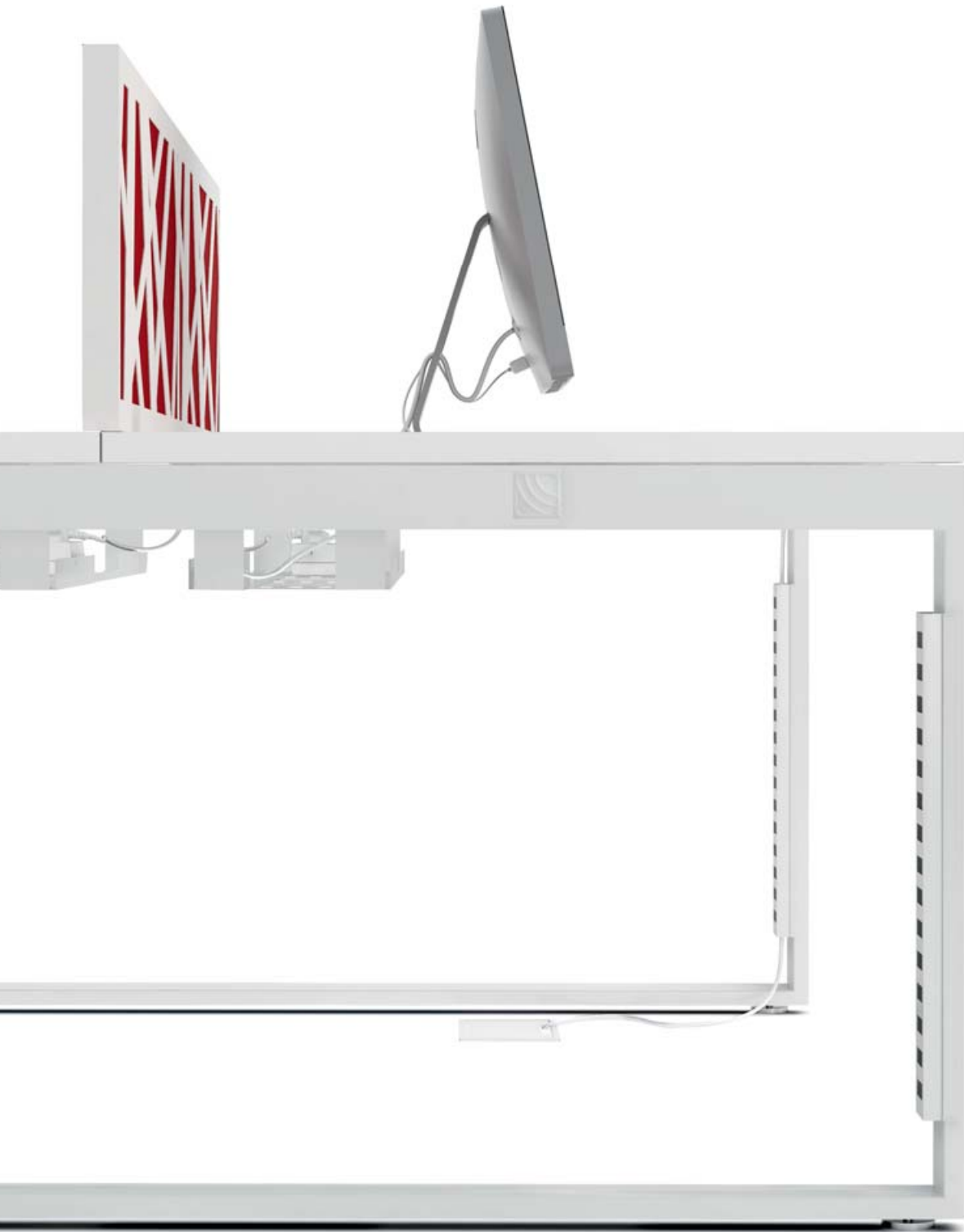

YAN_Z

YAN promotes interaction when employees spend time in teams and allows for privacy when needed. YAN meets office demands by improving performance and customer satisfaction. Thanks to its coherent attributes you can organize your office and reinvent a creative and functional space.



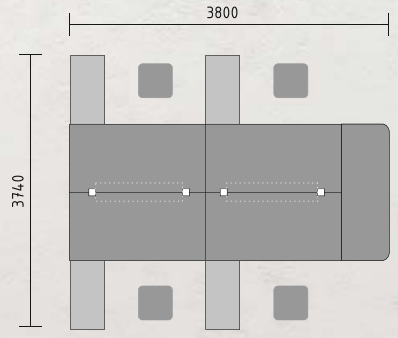

- ZBN05 X 2 MANAGERIAL DESK WITH STORAGE 1600/3740/740
- S16 X 2 METAL CABLE TRAY 1150/162/123
- SKP13 X 4 PILLOW 416/600/40
- PL180 EXTENSION 1600/600/28
- A3L08 X 2 TAMBOUR STORAGE 1200/432/1129
- SAVA X 4 CHAIR 660/610/1050-1150
- CAN11 X 2 CANOE LAMP 1105/360/360

YAN_Z

Side desk storages for both single desks and benches act as a construction element reducing the need for an additional leg thus maximizing the space underneath the desk. Wide variety of storage solutions allows for a tailor-made office interior.

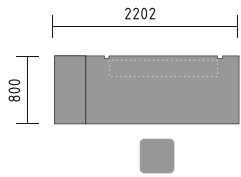

ZBN08L DESK 1800/800/740
KRT74L PEDESTAL 402/800/740
UN16 MFC MODESTY PANEL 1600/18/400
SAVA CHAIR 660/610/1050-1150

EXAMPLES OF STORAGE ARRANGEMENTS



- ZBN16L EXTENDING ELEMENT 1600/1600/740
- BZB16 WORKTOP - DOUBLE 1600/1600/83
- KRT74LP X 2 PEDESTAL 402/800/740
- KRT74L PEDESTAL 402/800/740
- KRT74P PEDESTAL 402/800/740
- S16 X 4 METAL CABLE TRAY 1150/162/123
- S93 X 2 VERTICAL HITCH 470/62/34
- ZP30 X 2 ZIG-ZAG PANEL 1590/26/350
- SAVA X 4 CHAIR 660/610/1050-1150

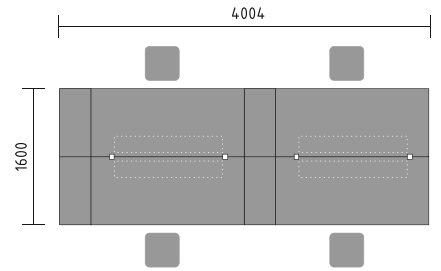

YAN is a simple yet multi-functional system which blends well into an office space arrangement. Its flexibility allows for a quick response to different office work requirements. Sliding desk tops give easy access to cable management. Distinctive panel designs enable to build an office of a particular character.

YAN_Z

YAN has been designed to offer the possibility of combining different components into a multi functional office layout. Tambour or sliding door storages, high or desk level can be used as an end element. Different height and functionality pedestals may act as both dividing or finishing section; individual or team storage.



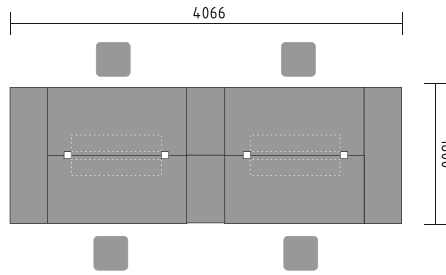

- BZB14** X 2 WORKTOPS -DOUBLE 1400/1600/83
- BA2L08** X 2 TAMBOUR STORAGE 1600/432/740
- S14** X 4 METAL CABLE TRAY 950/162/123
- ZT2** X 2 CITY PANEL 1370/47/360
- SAVA** X 4 CHAIR 660/610/1050-1150

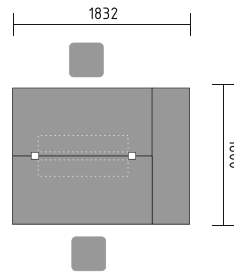

- ZBN14L** DESK 1400/1600/740
- BA2L08** TAMBOUR STORAGE 1600/432/740
- S14** X 2 CABLE TRAY 950/162/123
- ZT2** PANEL CITY 1370/47/360
- ZS01** SLIDING DOOR STORAGE 2000/434/1129
- SAVA** X 2 CHAIR 660/610/1050-1150



EXAMPLES OF STORAGE ARRANGEMENTS



YAN_T





YAN_T

Simple and flexible, YAN's construction is practical for your desired space or can be conveniently changed on the go to reflect the needs of your office. Whatever the type of workplace, YAN blends well in a different office situations.



- BRN06 X 2 STRAIGHT DESK 1600/800/740
- S16 X 2 METAL CABLE TRAY 1150/162/123
- S93 X 4 VERTICAL HITCH 470/62/34
- S87 X 2 CPU HOLDER 212/460/600
- IKRT13 X 2 PEDESTAL 402/600/586
- IA3104 X 3 STORAGE 801/432/1129
- ZW818 X 2 FREE-STANDING PANEL 800/38/1800
- SAVA X 2 CHAIR 660/610/1050-1150

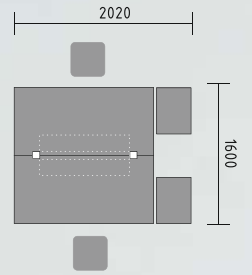

YAN_T

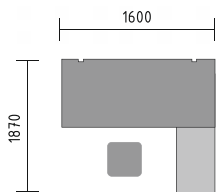

BRN01 MANAGERIAL DESK WITH STORAGE 1600/1870/740
UN16 MFC MODESTY PANEL 1600/18/400
SAVA CHAIR 660/610/1050-1150

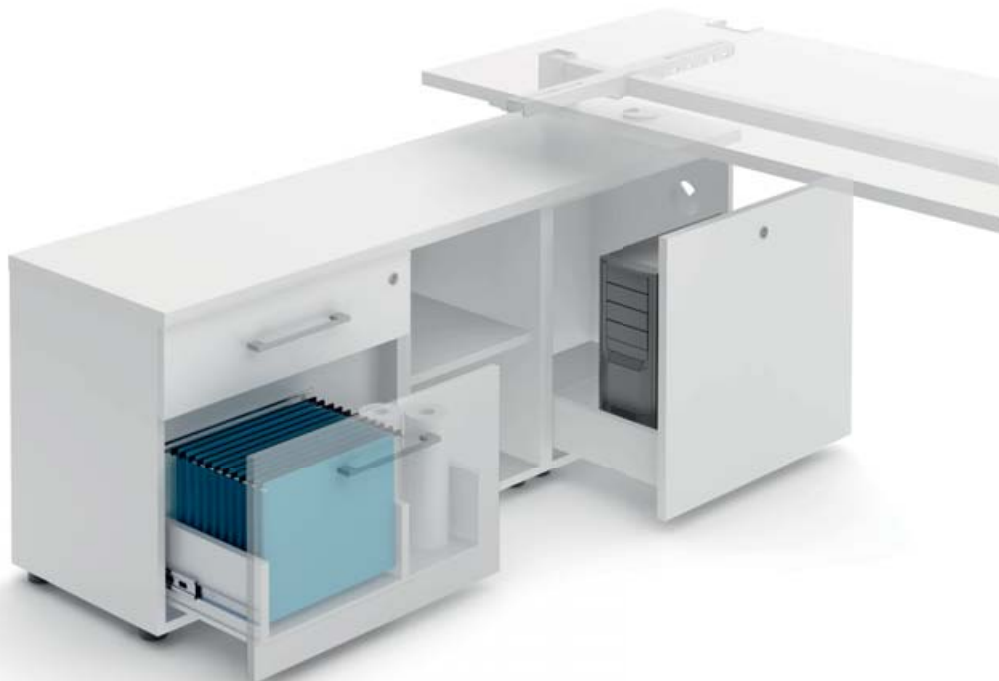

YAN managerial storage was designed to optimize and organize the work space. It is a construction element of the desks eliminating the need for additional leg. Thought through storage interior allows to hide a computer box as well as suspension files and personal belongings.

YAN sliding tops give access to horizontal cable management.
Desk's construction offers an extraordinary ergonomic qualities
with a large working area and all necessary advises and items within an easy reach.



YAN_T

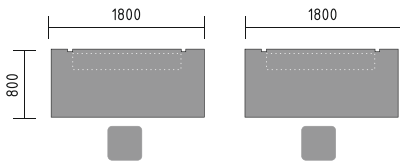

- BRN08R X 2 HEIGHTS ADJUSTABLE DESK
- S18 X 2 METAL CABLE TRAY
- S94 VERTICAL CABLE DUCTIN Ø140/750
- A3504 STORAGE 801/432/1129
- A3104HZ X 2 STORAGE WITH HPL FRONT
- SAVA X 2 CHAIR 660/610/1050-1150



YAN not only serves your present day basic needs but provides an answer to growing demands of the future office. YAN offers desks with manual height regulation. When the need arises you can comfortably set and regulate the height to your liking and situation.





YAN_M





YAN_M

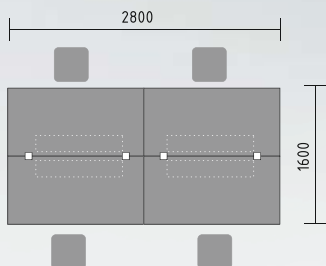

- BLN14 BENCH 1400/1600/740
- BLN14L EXTENDING ELEMENT 1400/1600/740
- S14 X 4 METAL CABLE TRAY 950/162/123
- S93 VERTICAL HITCH 470/62/34
- ZM14 X 2 ACOUSTIC PANEL 1390/38/350
- ZN14 DIVISORY FABRIC SIDE PANEL 800/38/650
- A6505 X 8 STORAGE 1000/432/2185
- A14M X 2 MANAGER STORAGE 1400/432/600
- SAVA X 4 CHAIR 660/610/1050-1150



YAN is the ultimate solution for companies that have multiple project teams who need more room to work and positively interact. YAN was developed in such a way that essential ideas can be exchanged. This is why you can use the panels interchangeably by dividing your workplace into straight or intersecting sections. In our offer, you can find five different types of panels which differentiate themselves by shape, finish and color.

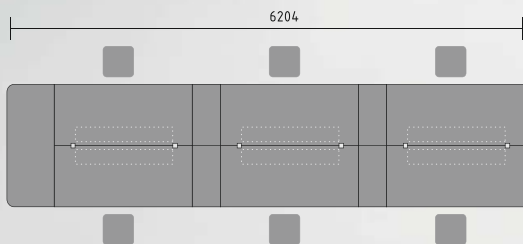

- BLN14L** X 2 EXTENDING ELEMENT 1400/1600/740
- BZB14** WORKTOP - DOUBLE 1400/1600/83
- PL180** EXTENSION 1600/600/28
- S16** X 6 METAL CABLE TRAY 1150/162/123
- S93** X 4 VERTICAL HITCH 470/62/34
- KCD80LP** X 4 CARGO PEDESTAL 402/800/1100
- ZT3** X 3 FABRIC PANEL CITY 1570/47/560
- SAVA** X 6 CHAIR 660/610/1050-1150

One of the most important elements in planning your ergonomic office space, is the functionality of your office furniture. YAN system offers a solution for creating workstations using Cargo containers. Cargo fulfills its role not only as a construction element but also as a place to rearrange all of your crucial documents. This type of arrangement is important in achieving optimal performance.



BLN06L EXTENDING ELEMENT 1600/800/740
 S16 METAL CABLE TRAY 1150/162/123
 S87 CPU HOLDER 212/460/660
 KCD80P CARGO PETESTAL 402/800/1100
 SAVA CHAIR 660/610/1050-1150

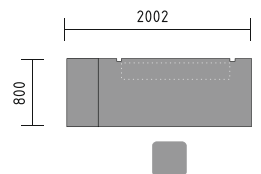

EXAMPLES OF CARGO STORAGE ARRANGEMENTS



YAN_M

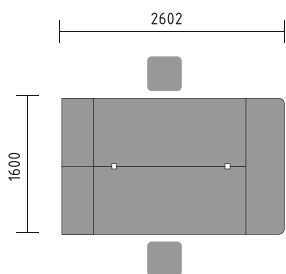

- BLN16L EXTENDING ELEMENT 1600/1600/740
- KRT73P PEDESTAL 402/800/740
- KRT73L PEDESTAL 402/800/740
- PL180 EXTENSION 1600/600/28
- S16 X 2 METAL CABLE TRAY 1150/162/123
- ZM16 ACOUSTIC PANEL 1596/38/350
- SAVA X 2 CHAIR 660/610/1050-1150



The main attribute of the YAN system is the possibility of easy configuring individual desks and benches in a number of ways.

Desk tops can be supported by metal legs, which come in four shapes to choose from, or different storage solutions.

By enlarging the work area with extending elements, a space for greater interaction can be easily build.

BZB14 WORKTOP-DOUBLE 1400/1600/28
BA2P08 X 2 SLIDING DOOR STORAGE 1600/432/740
S14 X 2 METAL CABLE TRAY 950/162/123
SAVA X 2 CHAIR 660/610/1050-1150

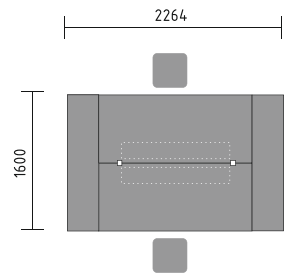

YAN_C





YAN_C

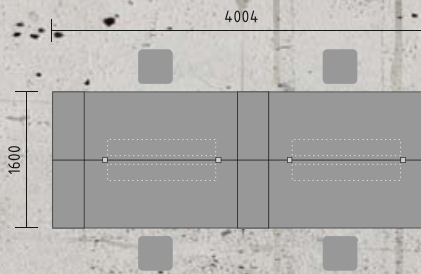

- BUN16L EXTENDING ELEMENT 1600/1600/740
- BZB16 WORKTOP-DOUBLE 1600/1600/28
- KRT74LP X 2 PEDESTAL 402/800/740
- KRT74L PEDESTAL 402/800/740
- KRT74P PEDESTAL 402/800/740
- S16 METAL VERTICAL TRAY 1150/162/123
- S93 X 2 VERTICAL HITCH 470/62/34
- ZT3 X 2 FABRIC PANEL CITY 1970/47/560
- A3104HZ X 3 STORAGE WITH HPL FRONT 801/432/1129
- SAVA X 4 CHAIR 660/610/1050-1150



YAN can be personalized to an individual office needs. An accessible array of colors and materials helps to add character to the whole office or to a selected area. Arranging an office with different panels add distinctive style to the office space design.



YAN_C

YAN promotes simplicity combined with a great variety and choice. Apart from many different styled panels, legs and storages there are different solutions for cable management. Combine vertical and horizontal cable organizer options to create a hassle free workspace environment. Each solution is universal for different YAN styles.

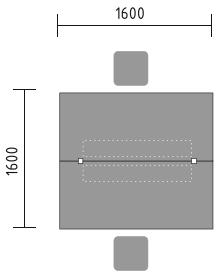

- BUN16** BENCH 1600/1600/740
- S16** X 2 METAL CABLE TRAY 1150/162/123
- S93** X 2 VERTICAL HITCH 470/62/34
- ZM16** ACOUSTIC PANEL 1590/38/350

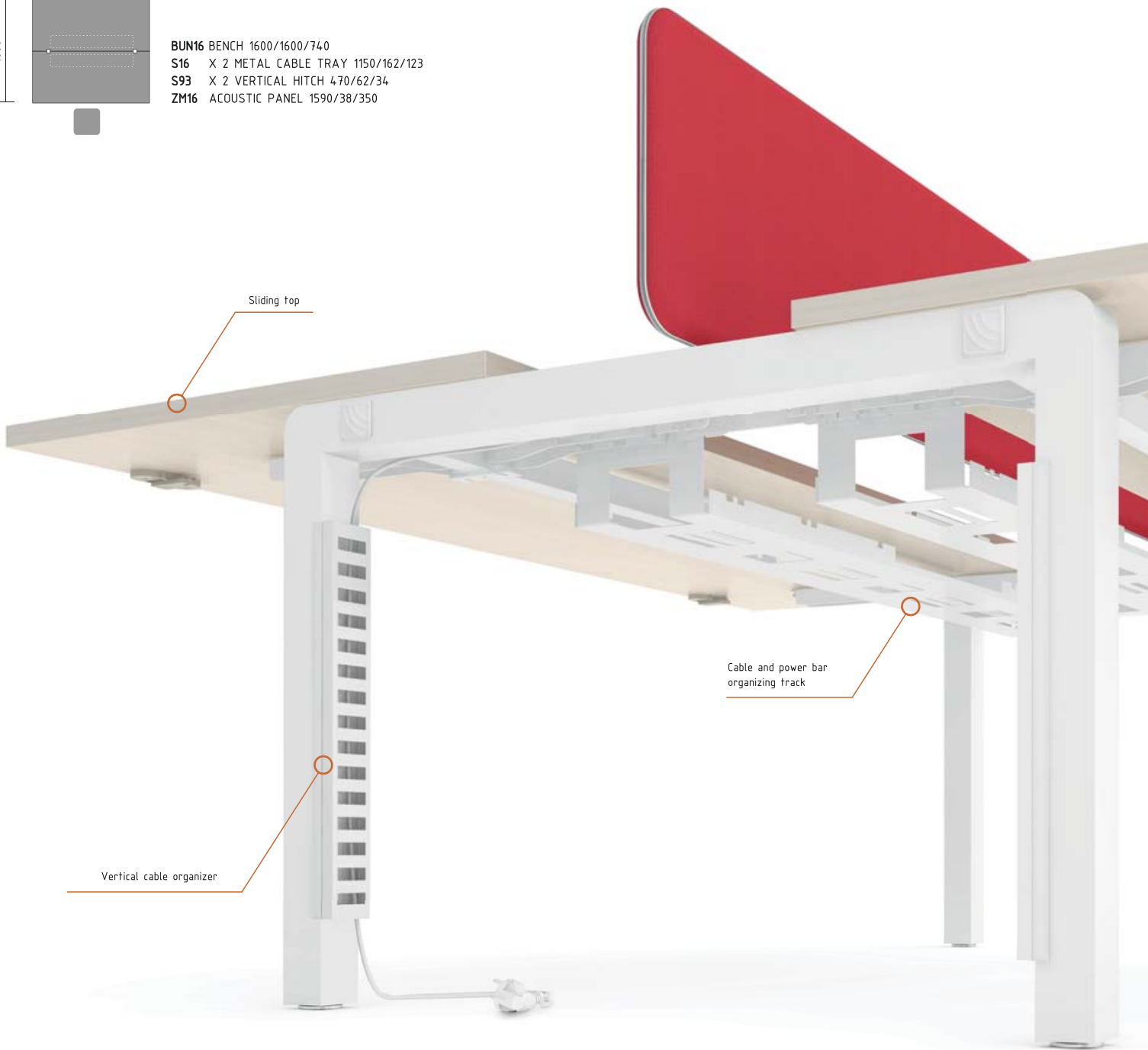

Elegant mediabox provides access to a power supply.
It can be used in desk tops and conference tables.



Unlocking latch for desk
sliding work surface

YAN's functional leg



YAN_C

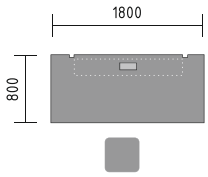

- BUN22 STRAIGHT DESK 1800/800/740
- M04 MEDIABOX 4X230V; 2XRJ45; 1XUSB
- S18 METAL CABLE TRAY 1350/162/123
- UN16 MFC MODESTY PANEL 1600/18/400
- ZS01 SLIDING DOOR STORAGE 2000/432/1129
- CAN11 CANOE LAMP 1105/360/360
- SAVA CHAIR 660/610/1050-1150



YAN represents a line of office furniture which can be very individual and personal and at the same time have the integrating factor with the rest of the office space. YAN has been designed to not only serve multi-station offices, but also for creating professional spaces for managers and directors. Combined with side tables, and partition walls a complete and cozy work environment can be created.

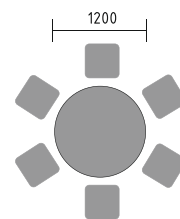

ST12 TABLE Ø1200/730
ZW818 X 3 FREE-STANDING PANEL
GAYA X 5 CHAIR 660/510/825



YAN_CONFERENCE

In every company there is a need for a meeting space where business dialogue can be conducted. YAN offers a wide range of conference and meeting tables covering different styles to blend in with the rest of the office design.



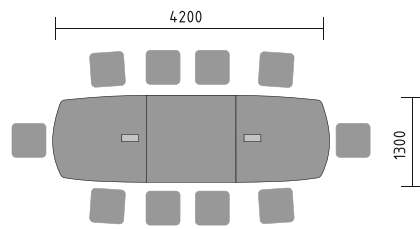

- BUN24S TABLE 1300/1400/740
- BUN24L TABLE 1300/1400/740
- M04 MEDIABOX 4X230V; 2XRJ45; 1XUSB
- BUN24P TABLE 1300/1400/740
- M04 MEDIABOX 4X230V; 2XRJ45; 1XUSB
- IA3P06 X 2 SLIDING DOOR STORAGE 1200/432/1129
- HPR2 X 2 HANDLES PRO 160/110/20
- SNL16 SUNBEAN LAMP Ø1440/410
- GAYA X 8 CHAIR 660/510/825



YAN_PANELS

YAN panels present different styles to suit individual needs. Functionality of panels together with the diversity of design and characteristic patterns give you customized work area in a new look.

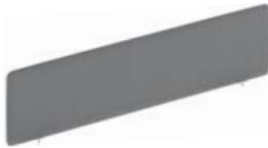

1190-1790 mm



ACOUSTIC PANELS

MFC PANELS WITH FABRIC SCREENS MFC PANELS

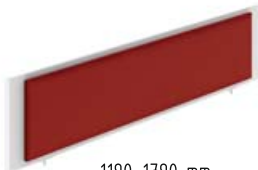

1190-1790 mm



1190-1790 mm



800 mm



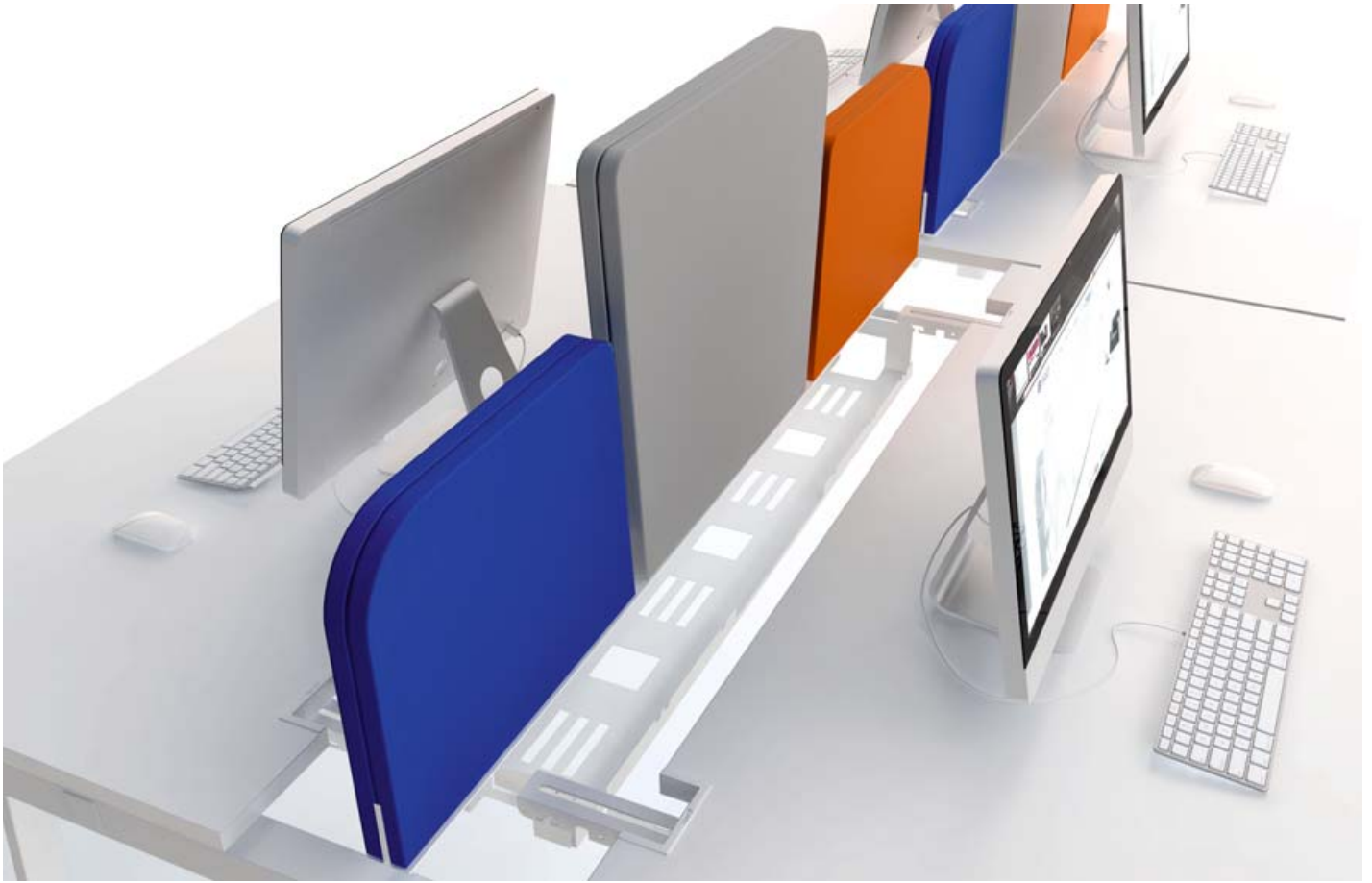

CITY PANELS



1570-1770 mm



1570-1770 mm



1170-1370 mm



Open workspaces do not have to be boring. Vibrant colors and diverse forms of panels, break up the static nature of the system, promoting creative inventiveness.



1190-1790 mm

ZIG-ZAG PANELS

YAN_PANELS

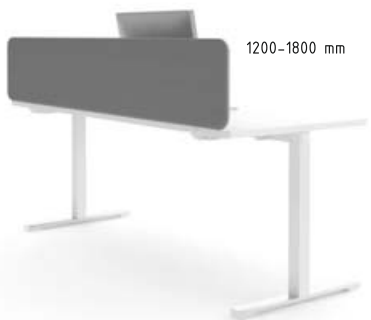
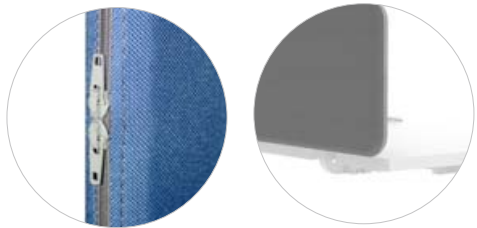

ACOUSTIC PANELS h350 mm

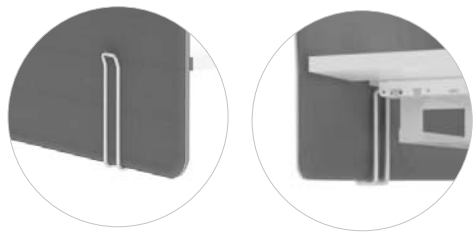

ACOUSTIC PANELS h650-800 mm



Simple and elegant partition walls can act both as regular panels, dividing work stations into individual sections or as standard partition walls dividing open space depending on the needs.

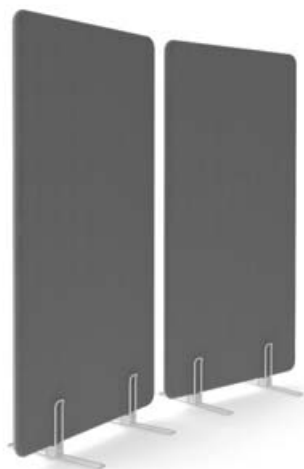

1200-1800 mm

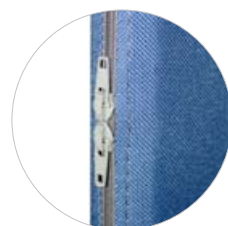

ACOUSTIC PANELS h1200-1800 mm

YAN_ELEMENTS

YAN presents a large variety of ways in which a desk top can be supported. These include four different shapes of legs, and several storage options. It allows for creating simple yet functional work areas.

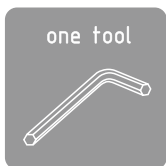
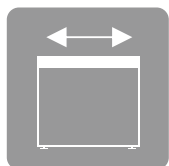

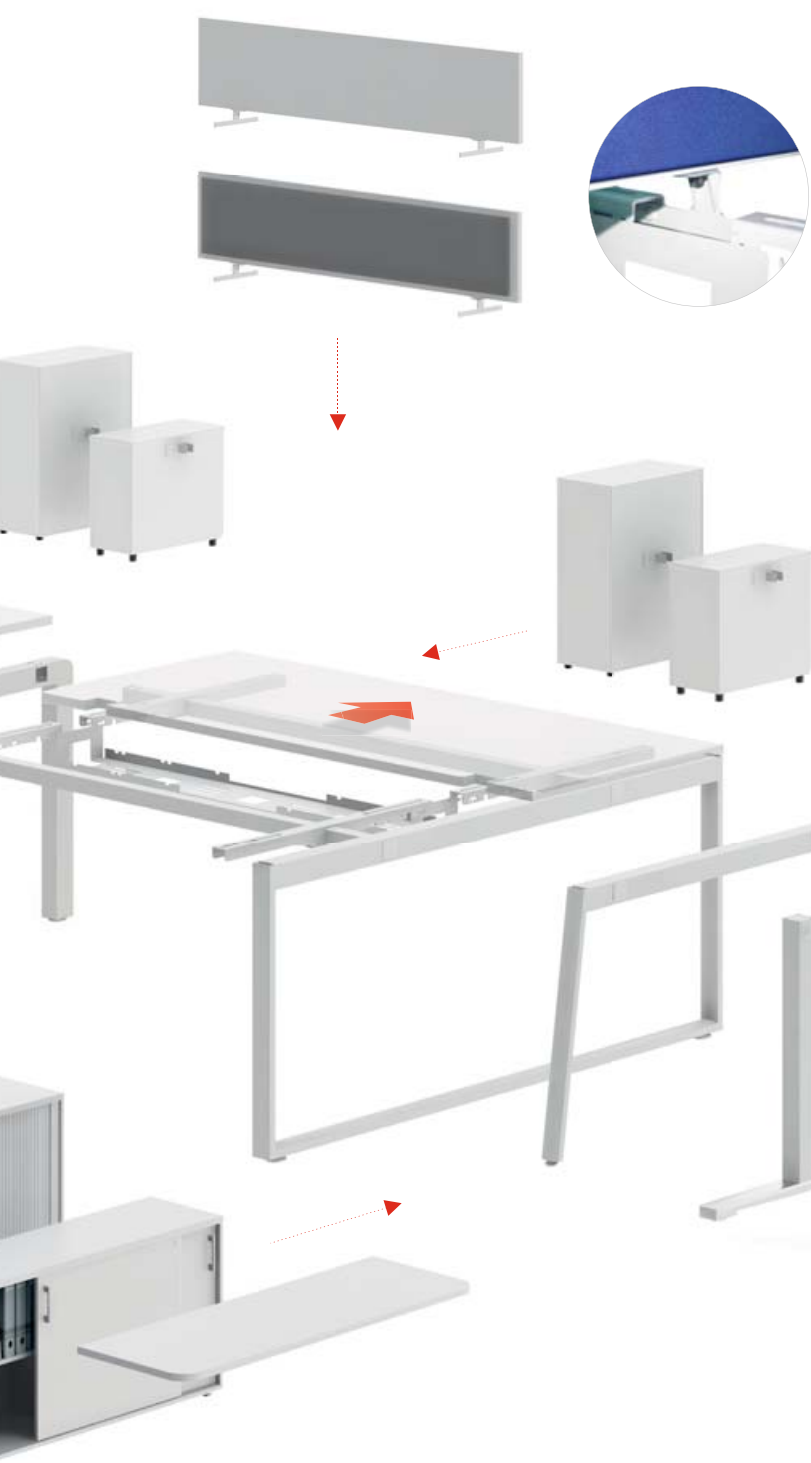
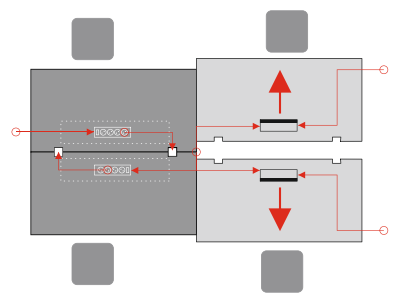
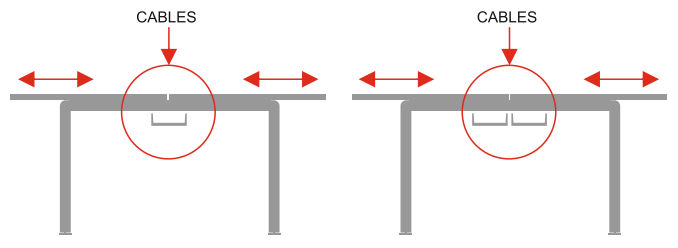

YAN_ELEMENTS

- QUICK AND EASY ASSEMBLY SYSTEM
- SLIDING DESK TOPS: DIRECT AND EASY CABLE MANAGEMENT ACCESS
- VERSATILE AND SMART
- HEIGHT ADJUSTABLE: MANUAL AND ELECTRIC OPTIONS

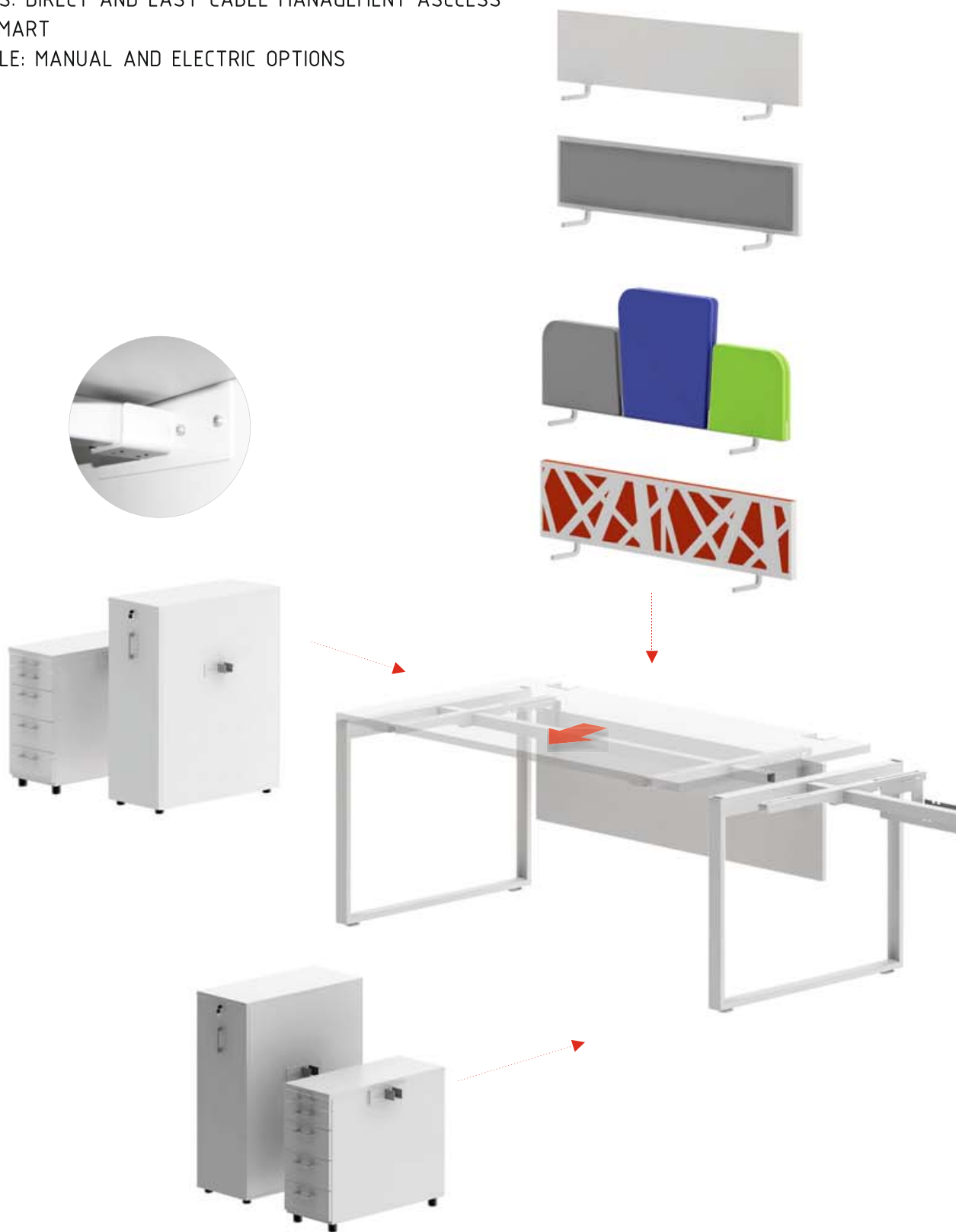

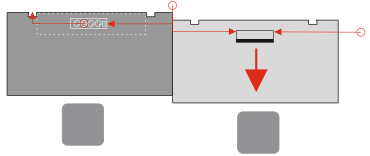
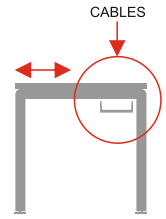
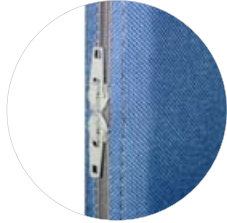
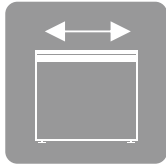

CABLE MANAGEMENT



VERTICAL CABLE HITCH S93
CPU HOLDER S83



VERTICAL CABLE DUCTING S94 FOR HEIGHT
ADJUSTABLE DESKS



VERTICAL CABLE DUCTING S81
TOP ACCESS M05



MEDIABOX M04:
2XRJ45, 1XUSB, 4X230V

M04 - the product has been developed with several solutions to guarantee an easy, in-built arrangement of all wires required for electricity, telephone and data transfer



HORIZONTAL METAL CABLE TRAY

- DIFFERENT LENGTHS
- UNIVERSAL FOR INDIVIDUAL DESK OR BENCH SOLUTIONS

CHESTNUT



CANADIAN OAK



POLAR BIRCH



WHITE PASTEL



GROMMETS AND PRESS BUTTONS
- DIFFERENT COLOURS

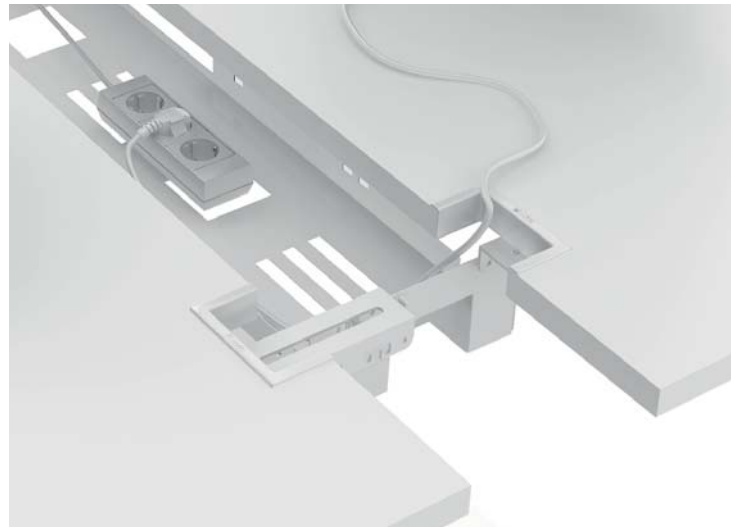

SAVA

SAVA is a fusion of class and originality. The customized chair mechanisms allow for the adjustment to one's personal taste and posture. Its rich palette of fabrics, and bold colors is an asset in creating a modern office.



GAYA

This is the ideal popular chair utilized in conference rooms, waiting rooms, reception areas and entrance halls. There are two types of chrome bases available: a 4 legged base or a sleigh runner. They are easily stackable.

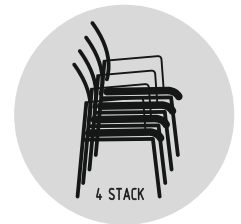

YAN_M

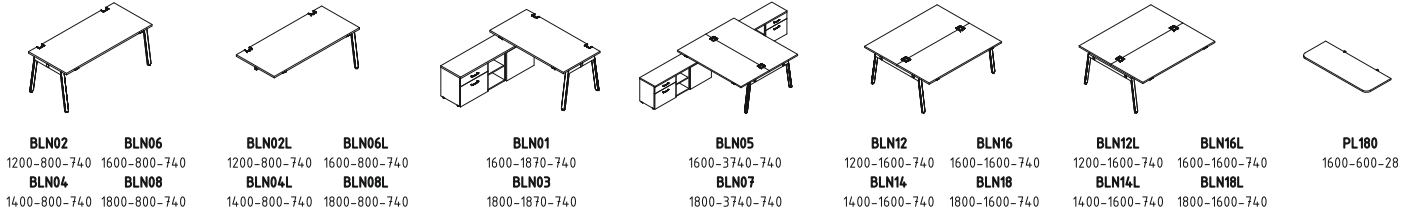

YAN_Z

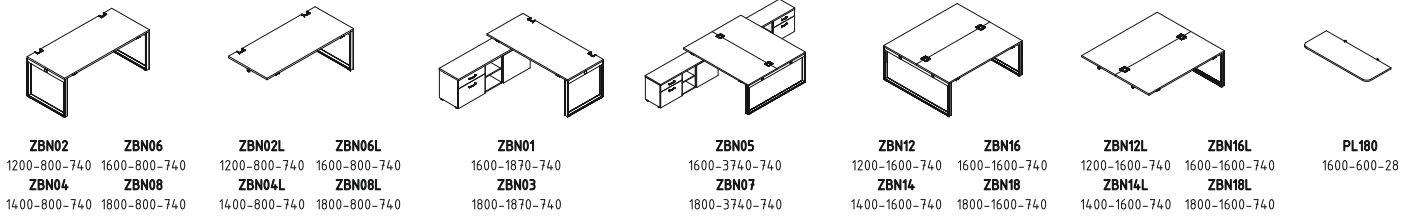

YAN_T

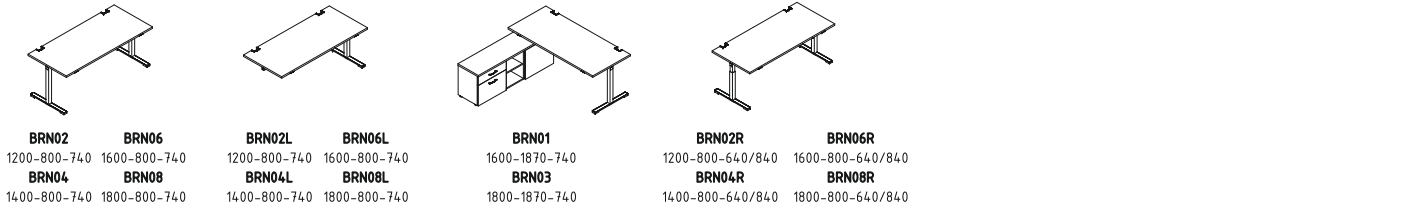

YAN_C

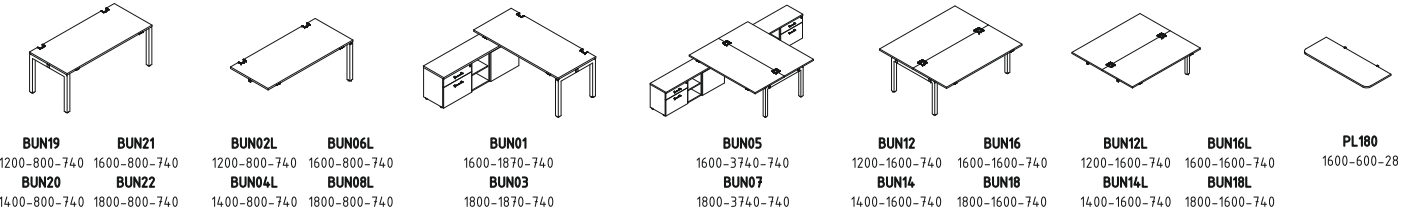

DRIVE

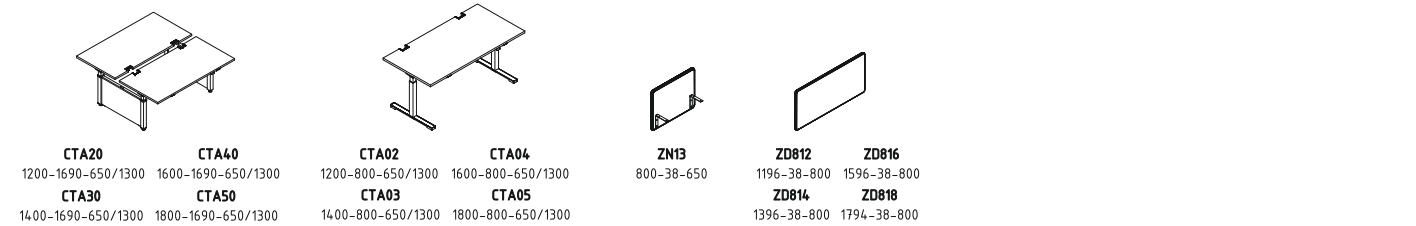

PEDESTALS

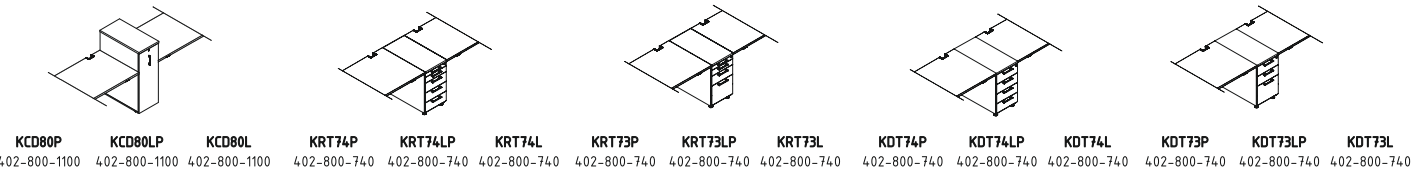

STORAGES

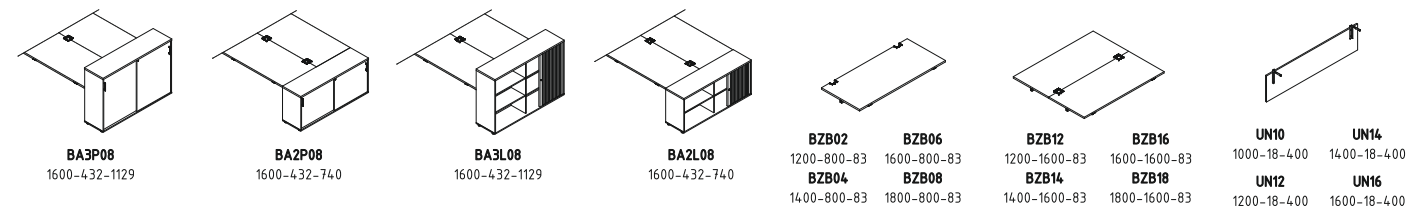

PEDESTALS

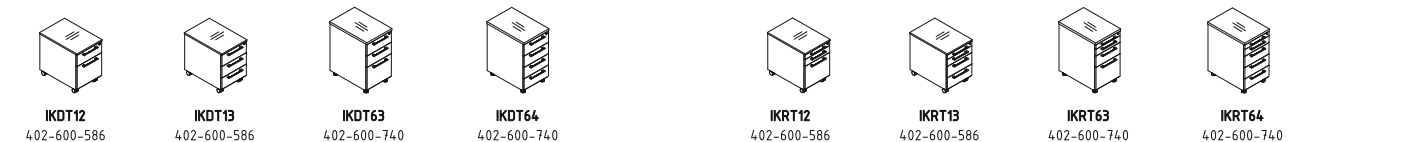

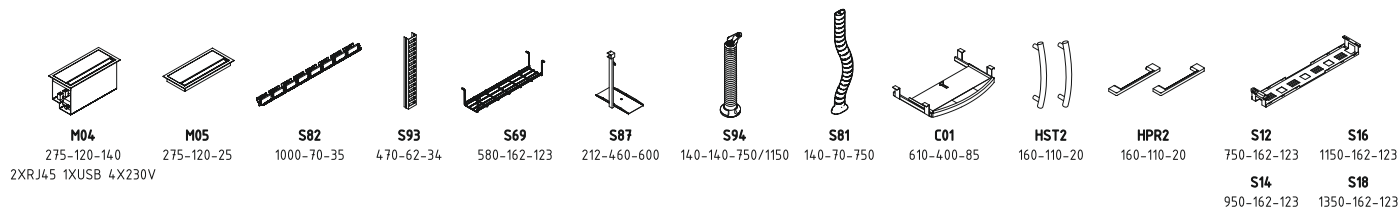
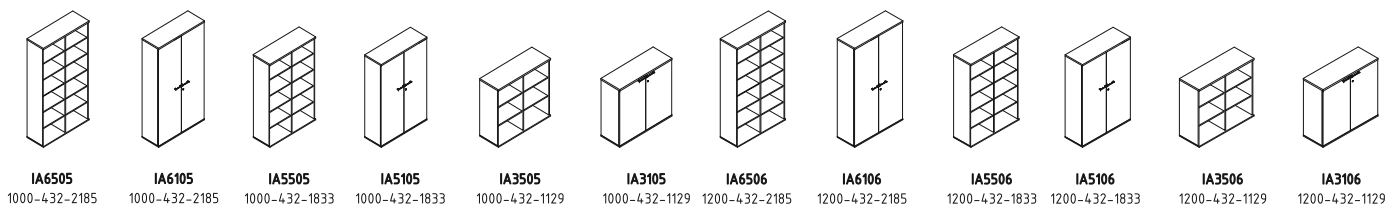
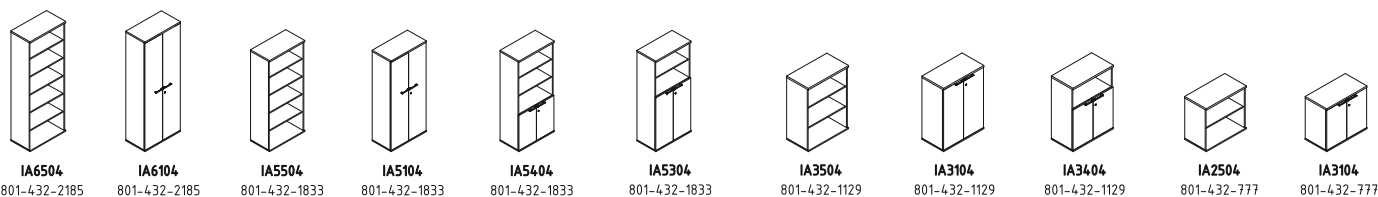
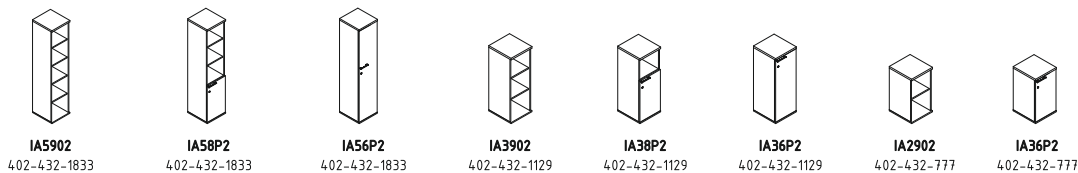
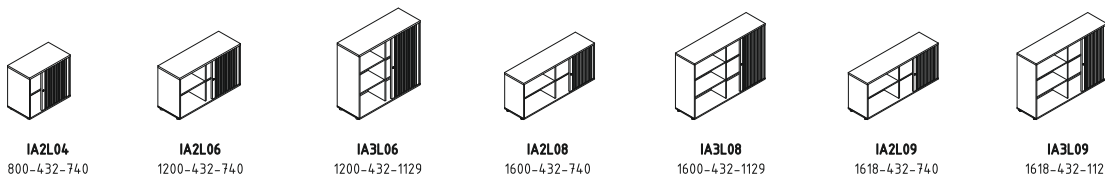
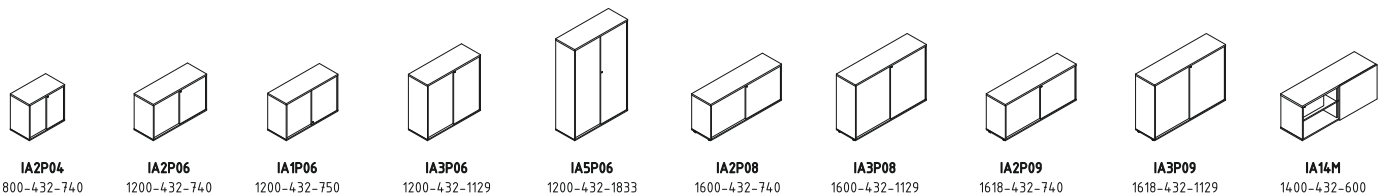
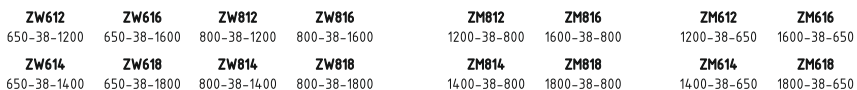
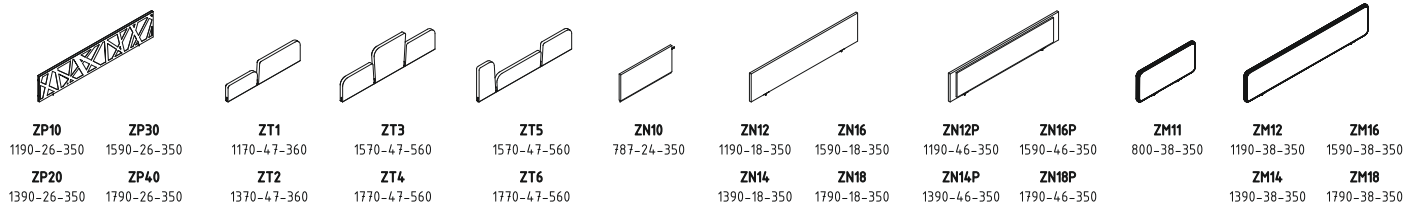

Images in the catalogue may show products slightly differently from the original version. Colours of shown materials may differ from the real ones. The producer reserves a right to introduce changes of colours and patterns of the presented products.

The manufacturer reserves the right to introduce alterations to the products and their marking without changing the general design.

The present catalogue does not constitute a legally binding offer and is published solely for information purposes. Order may be placed only on the basis of the current price lists, available at authorised distributors.

