

Edition 2 | **2017**
supplemented edition

HUSH

the art of silence



www.hushdesign.pl

HUSH story began with a simple idea:
improve the acoustic properties & style
of every interior.

About Us	05
Our Designers	07
About Sound	08
Design for Silence	10
Blocks	13
Puzzle	19
Duo	23
Wall	29
Cone	35
Tower	39
Print	43
Fabrics	46
Fixing Systems	48



The art of silence.

Sound has always been with us. Yet, with the technological and economic development, more and more sources of unwanted noise disturb our daily lives. The latest trend in design - large open spaces - fosters collaboration, but also creates sub-optimal acoustic environment. An environment where all background noises of conversations, ringtones or printers subconsciously distract us.

HUSH offers acoustic panels that reduce unwanted noise in all types of interiors. We make sure our products are simple, adaptable and of high quality. Following our motto - **the art of silence** - we are here to marry noise reduction with timeless, sustainable design.



Together with experts in the field of acoustics, we develop products that meet the highest standards in absorbing and blocking unwanted noise.

Our screens and panels are tested in professional acoustic laboratories according to international norms: EN ISO 354, EN ISO 11654 and EN ISO 10053.



From the best performing melamine foam to recyclable and fire-resistant fabrics, we carefully select the finest materials for our panels.

Our production process provides the precision of the most innovative machines combined with a handcrafted finish.

Our Designers

We believe great performance and quality need to go hand in hand with style. To transform technical products into works of art, we collaborate with renowned designers. Our pure lines suit all environments where we work and socialize.



Paul and Kate Brooks are English Designers living in France and working together from their studio in Germany. Both studied design in London - Paul at the Royal College of Art and Kate at St Martin's College. They design products with a quiet clarity and an artful twist for clients in Europe and North America. Their designs have gained international recognition with awards from organisations such as IF, Good Design Award, Red Dot and Neocon.

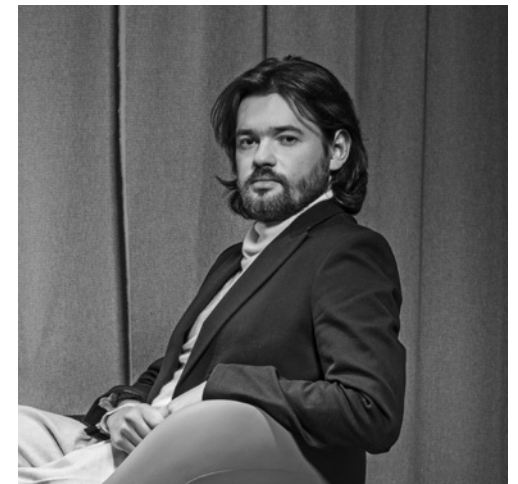

Jakub Sobiepanek is a Polish Designer working in his studio in Warsaw. He graduated with honors from the Academy of Fine Arts in Warsaw. His master thesis about bringing back to life the icons of Polish design, was awarded the best thesis of 2012. Apart from the design work, Jakub is also the creative director of Vzor – a Polish furniture brand, producer of the iconic RM58 chair (www.vzor.com).

About Sound

What is sound?

Sound can be described as pressure waves fluctuating in the air. We hear sound when air pressure variations are transmitted to our ears and further transferred as nerve signals to our brains. Sound level is measured in Decibels (dB), and sound frequency in Hertz (Hz).

What is noise?

Noise is unwanted sound, for example background conversations, alarms and ringtones, electrical appliances or traffic noise.

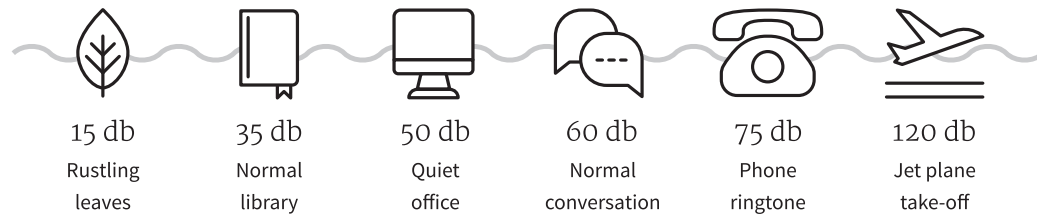



Reverberation time.

Reverberation Time (RT) is one of the most important terms in acoustics, because it shows how quickly sound/noise decreases after the sound source stops. The higher the RT, the bigger the „echo“ effect in a room. Sound waves which „meet“ hard surfaces like glass, bare floors or concrete are continuously reflected, creating an annoying background noise. It makes it very difficult to focus, listen and talk in comfort. A reverberation time that is too long in relation to the size and function of the room is the main cause of a poor acoustic environment.

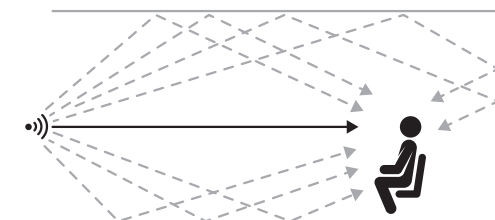
A balanced acoustic environment always depends on the purpose of the room. In a restaurant, a good acoustic environment may allow a certain degree of background noise as an element of social interaction. In an office however, background noise of colleagues chatting while we try to focus on our work, is clearly unwanted. In spaces with poor acoustic environment it is crucial to optimize the RT to a desirable level by installing properly designed sound absorbing products. HUSH products have been tested in professional reverberation chambers in accordance with the international standards EN ISO 354 and EN ISO 11654.



Reverberation. Multiple sound reflections.

-  sound source
-  direct sound
-  reflected sound

Absorption & Attenuation.

An ideal combination of sound absorption and sound attenuation can drastically improve acoustic comfort in any space. Sound absorption reduces unwanted noise and sound attenuation blocks it from travelling between spaces. HUSH products have been designed and tested to create a pleasant acoustic environment in your room.

Absorption.

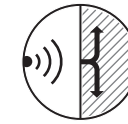

Sound absorption shows the ability to stop the sound wave that hits the surface and transform it into an unnoticeable heat energy. Sound absorbers improve room acoustics by eliminating sound reflections and reducing the reverberation time. Absorption is measured according to EN ISO 354 and can be expressed as:

- Sound absorption coefficient α . α ranges from 0 (total reflection) to 1 (total absorption). Weighted α_w results can be further classified into a specific sound absorption class, between A and E, where A means the highest sound absorption. This measure is used for sound absorbing elements covering surface of min. 10 m² on the wall or ceiling.
- Equivalent sound absorption area Am² compares the area of product analyzed to a perfect sound absorber. One Am² is equal to one square meter of full absorption. It is recommended to use this measure, rather than sound absorption class, for any single free-standing or desk acoustic screens.

Attenuation.



Sound attenuation shows the ability to reduce transmission of sound/noise through a screen. Screens with good attenuation play a role of sound shields between one space and another. Sound attenuation is measured according to EN ISO 10053 and is expressed as sound level decrease in dB thanks to blocking properties of an acoustic screen.

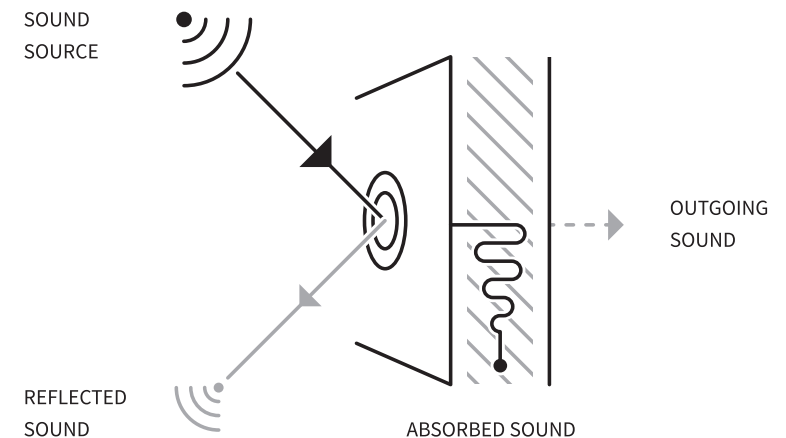

Design for Silence

Our day in the office requires constant switching between focusing on individual tasks and team work, where we often disturb each other in all parts of the office. Scientific research shows that continuous noise at work results in distraction, stress and may increase the rate of errors, burn-outs and even sick leaves. It is therefore crucial to aim for a balanced acoustic environment while designing all spaces in our offices.

Welcome area.

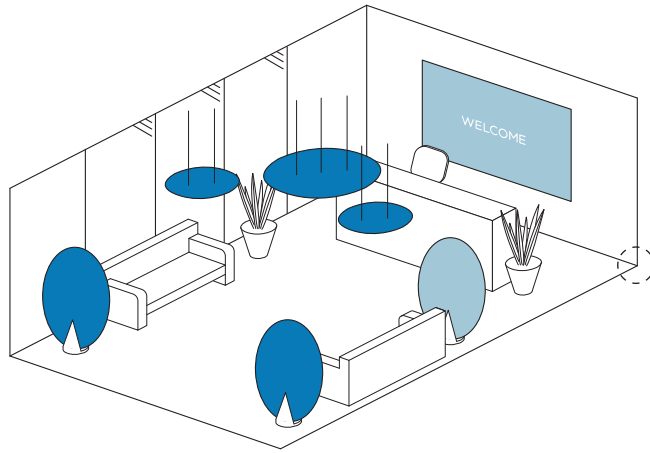

Featured products:
Blocks ceiling
Cone Round
Print

Reception is usually a vast space with high ceilings and hard, reflecting surfaces on the ground and walls. Reception area is the showcase of your company, where guests should feel comfortable communicating with the reception staff or waiting for their meeting. Wall and ceiling panels with a high degree of sound absorption will create a more pleasant environment.

Focus area.

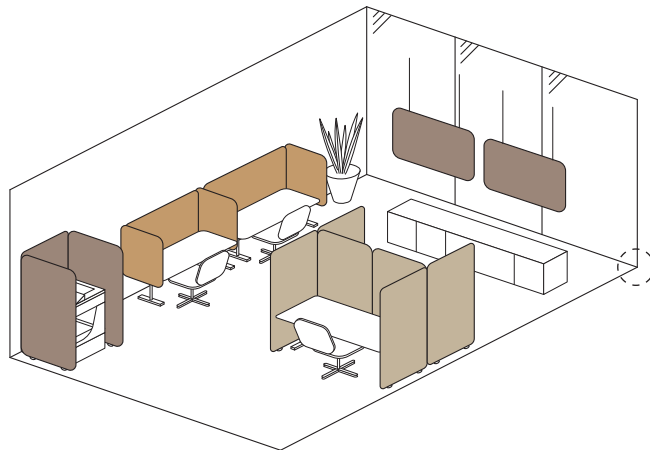

Featured products:
Duo hanging
Duo desk
Wall

We spend most of our working day at the desk, surrounded by co-workers, where we perform multiple tasks requiring high level of focus. In an open-space office, we should minimize speech and other background noises from spreading between workstations, by installing screens with great sound attenuation properties.

Formal meetings.

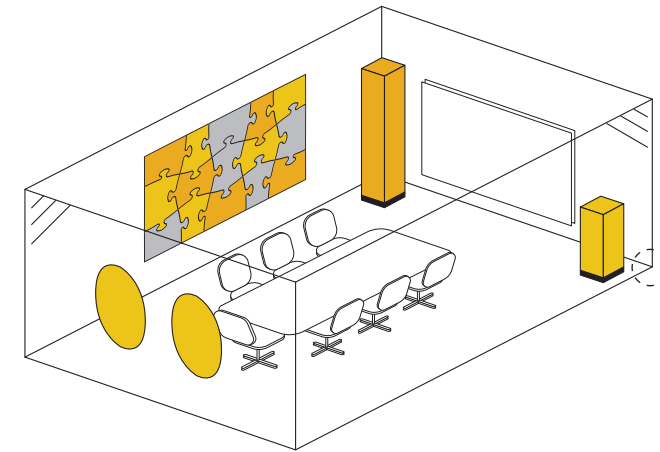

Featured products:
Puzzle
Tower
Blocks wall

Meeting rooms very often have one or two glass walls, and a whiteboard. These materials increase reverberation time and decrease speech clarity, which makes it very difficult to communicate with people in the room and on the phone. In these spaces it is recommended to use sound absorbing products on the wall and ceiling, or free-standing absorbers in case walls are occupied.

Informal meetings.

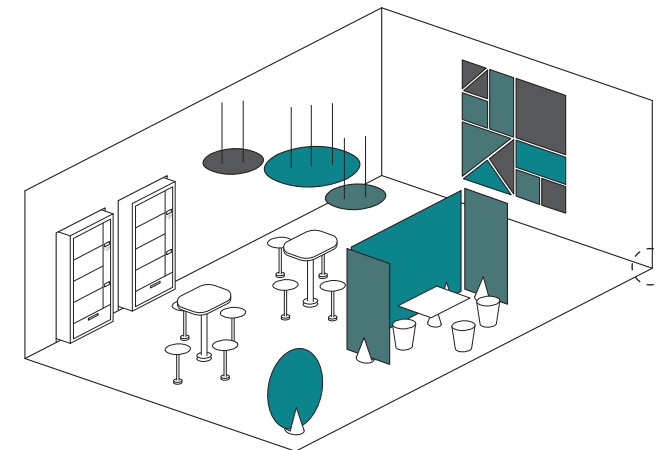

Featured products:
Cone Round
Cone Rectangle
Blocks ceiling
Blocks wall

In contemporary offices people tend to meet „over a coffee” in informal spaces, like breakout areas or kitchens. These are usually large spaces with a lot of background noise of people talking or walking by. In these spaces it is important to decrease the level of noise to allow clear conversations, but also separate this area to stop the noise from propagating to working areas.

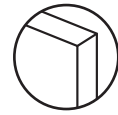

Wall panels

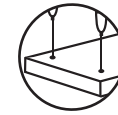

Hanging panels

Blocks

Design Paul & Kate Brooks



Blocks is an incredibly versatile family of acoustic wall and ceiling panels. Five classic shapes in various sizes and two thickness options offer endless configuration

possibilities. With Blocks you can keep it calm and make a simple repeat pattern, or let your imagination run free to create a complex piece of „art“.



Let your **imagination** run free.

Example of Blocks panels configurations

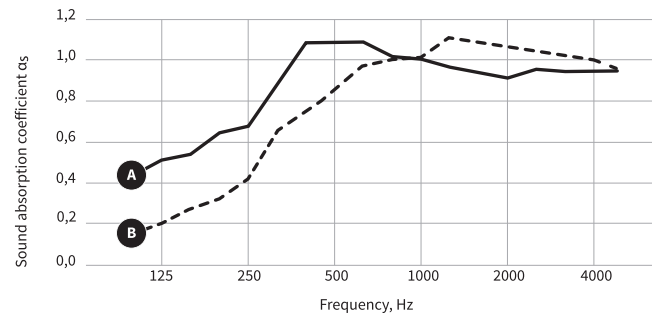
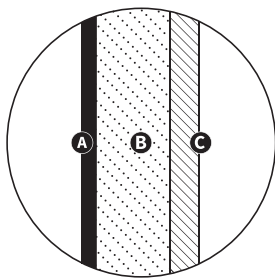
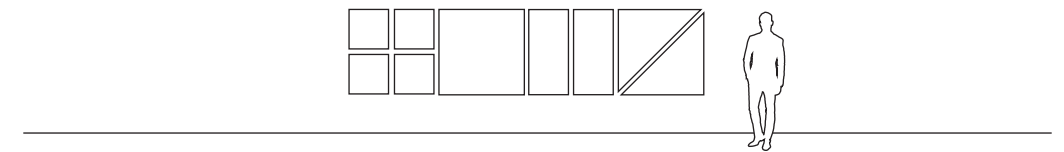

- A** - Fabric
- B** - Basotect® melamine foam
- C** - HDF board

- A** - 55mm Blocks panels $\alpha_w = 1.00$ (class **A**)
- B** - 35mm Blocks panels $\alpha_w = 0.75$ (class **C**)

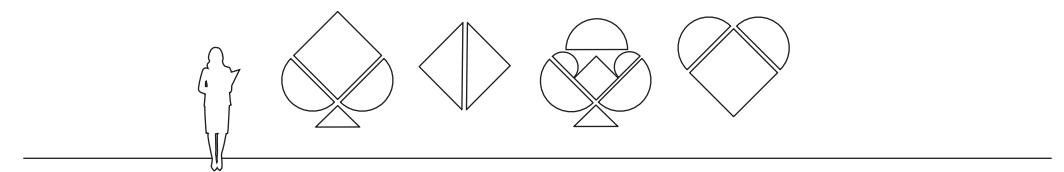

Blocks panels are made of ultra absorbing melamine foam and a thin HDF board, and are upholstered in fabric of your choice. Blocks are light and easy to install on all walls and ceilings.





The Blocks range has been developed together with an experienced acoustics laboratory. It has been certified according to EN ISO 354 as class A absorber (55mm panels) and class C absorber (35mm panels), absorbing 100% and 75% of unwanted noise respectively.



Blocks. Configure your product.





Choose your order specifics

HUSH

	01	02	03	04	05
Shape					
Size W x H [mm]	600 x 600 900 x 900 1200 x 1200	600 x 600 636 x 636* 848 x 848** 900 x 900 1200 x 1200	600 x 300 900 x 300 900 x 450 900 x 600 1200 x 600	∅ 600 ∅ 900 ∅ 1200	∅ 600 ∅ 900 ∅ 1200
		* ½ of 900 x 900 triangle ** ½ of 1200 x 1200 triangle			

Thickness [mm] **35** = 35mm providing high sound absorption (class C; aw = 0,75)

55 = 55mm providing ultra high sound absorption (class A; aw = 1,00)

Fixing systems	A 	Click button connectors for wall mounting
	B 	Magnets for wall mounting (recommended for thick walls)
	C 	Wire system for ceiling mounting
	D 	Dual lock fasteners for back of furniture or glass

Fabrics Available in all our standard fabrics (details on p. 46 or www.hushdesign.pl).

Finish type [optional]  Option of mixing 2 colours of the same fabric on front and sides of the panel.
How to order:
EV2 / EV4 (EV2 = front ; EV4= sides)
EV4 (EV4 = front & sides)

Order example BLOCKS - 01 - 600 x 600 - 55 - B - EV2 / EV4
BLOCKS - 04 - 900 - 35 - C - EV9

the art of silence

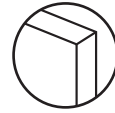
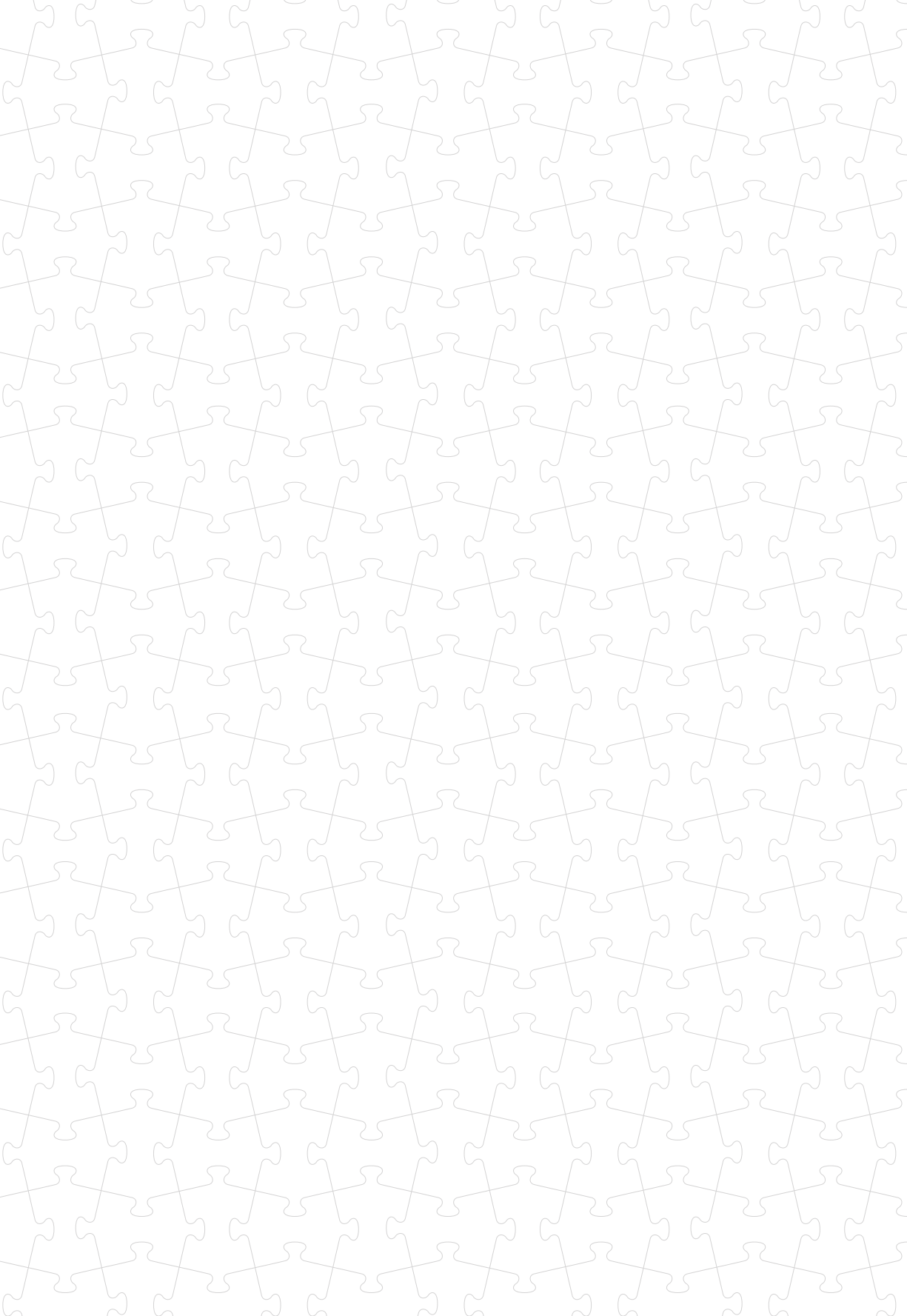

Wall panels

Puzzle

Design Paul & Kate Brooks



Puzzle is a range of acoustic wall panels inspired by the classic jig-saw shape. The design offers a series of five puzzle pieces. By combining these elements you can

build infinite tableau structures or link random pieces in free style. Stylish, fun and reassuringly familiar.

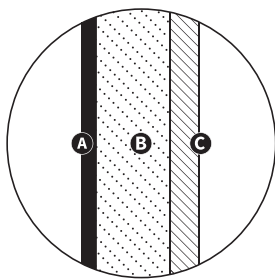

- A** - Fabric
- B** - Basotect® melamine foam
- C** - HDF board

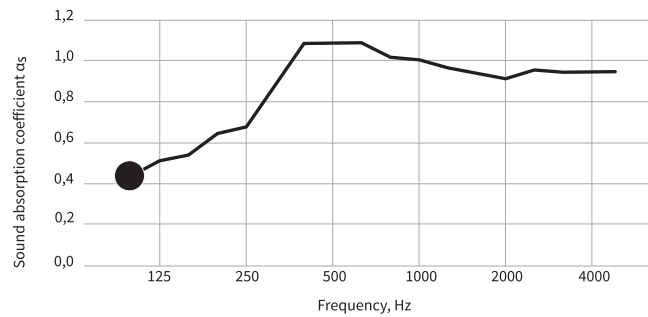

● - 55mm Puzzle panels
α_w = 1.00 (class A)

The core of Puzzle panels is made of melamine foam, which has outstanding sound absorbing properties. Puzzle panels are thoroughly sewn and upholstered in fabric of your choice.

Puzzle panels are certified according to EN ISO 354 as class A sound absorbers, absorbing 100% of unwanted noise. They can be used on walls of reception halls, restaurants, canteens or any other spaces needing reduction of reverberation time.

Puzzle. Configure your product.

Choose your order specifics

HUSH

	01	02	03	04	05
Shape					
Size W x H [mm]	800 x 600	800 x 600	595 x 805	1005 x 600	1005 x 595
Thickness [mm]	55mm providing ultra high sound absorption (class A; α _w = 1,00)				
Fixing systems	A Click button connectors for wall mounting		B Magnets for wall mounting (recommended for thick walls)		
			D Dual lock fasteners for wall and glass mounting		
Fabrics	Available in all our standard fabrics (details on p. 46 or www.hushdesign.pl).				

Order example

- 2x PUZZLE - 01 - B - SY13
- 2x PUZZLE - 02 - B - SY13
- 4x PUZZLE - 03 - B - SY13
- 4x PUZZLE - 04 - B - SY13
- 3x PUZZLE - 05 - B - SY13

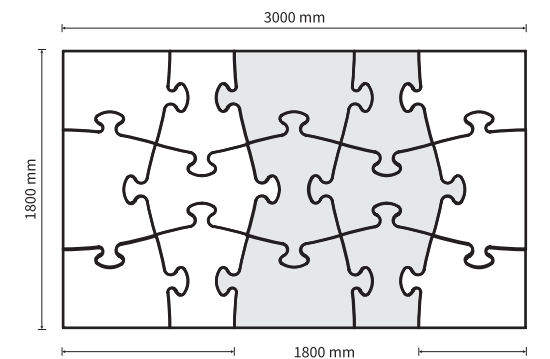

Example configurations:
 9 panels - 1800 x 1800mm
 15 panels - 3000 x 1800mm
 25 panels - 3000 x 3000mm

the art of silence

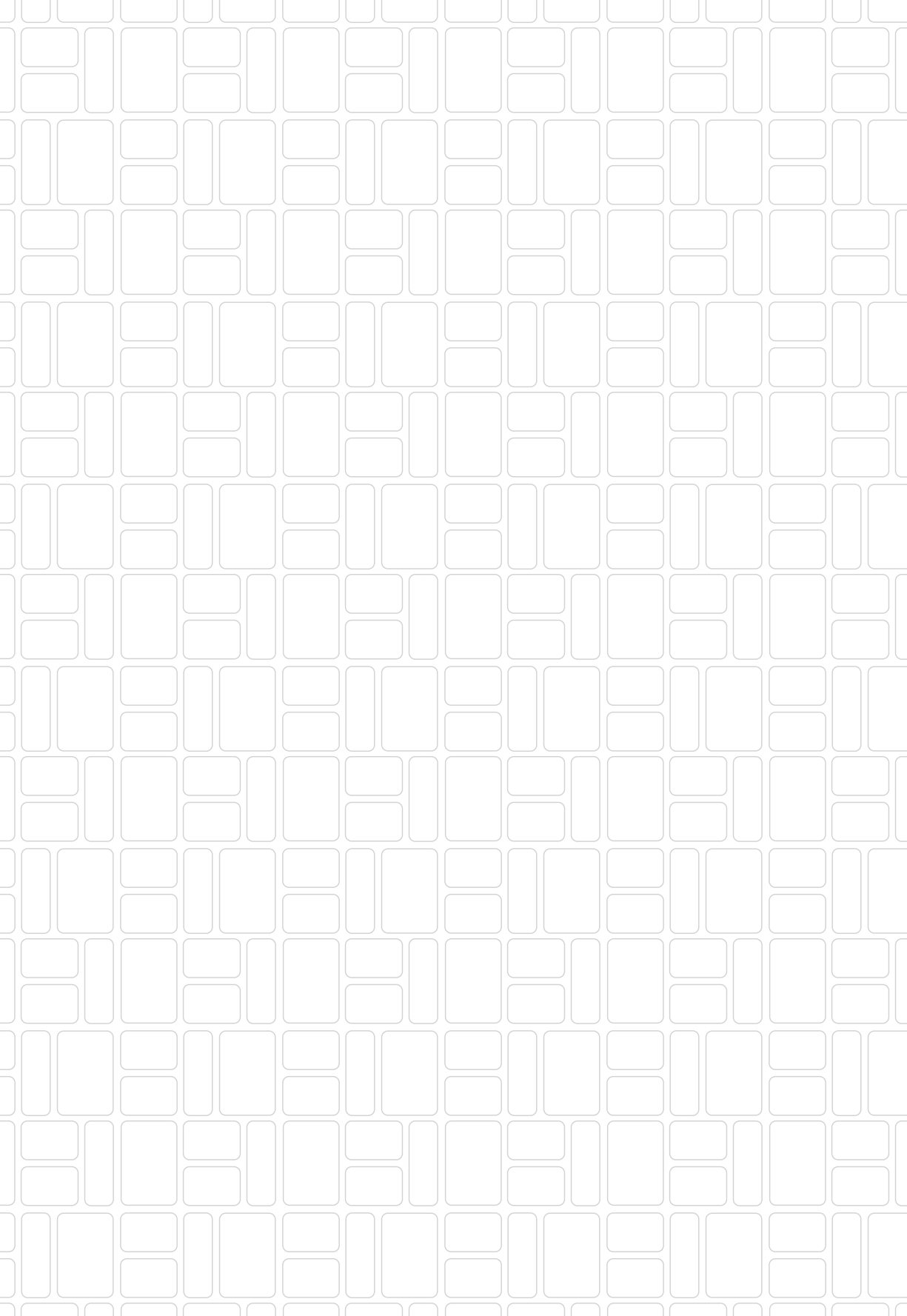

Desk screens

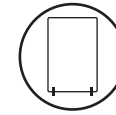

Standing screens

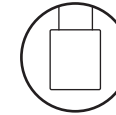

Hanging screens

Duo

Design **Paul & Kate Brooks**



Duo is a range of two-sided acoustic screens. They offer a perfect solution for absorbing unwanted noise in a simple, enduring form. Pure rectangular panels

with rounded corners suit every type of interior. Duo can be used as desk-up screens, free-standing screens or hanging panels.



One panel. Multiple installation systems.

Free-standing, hanging, desk-up screens

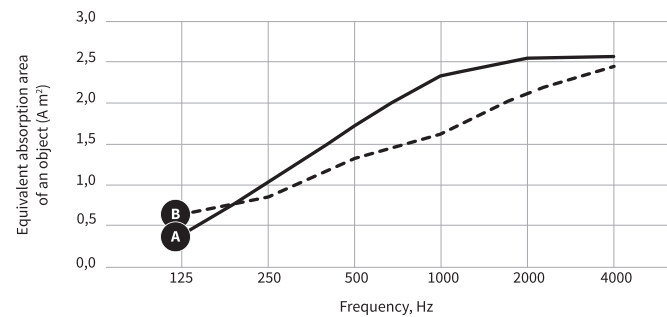
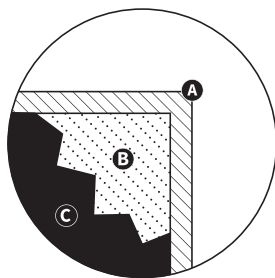
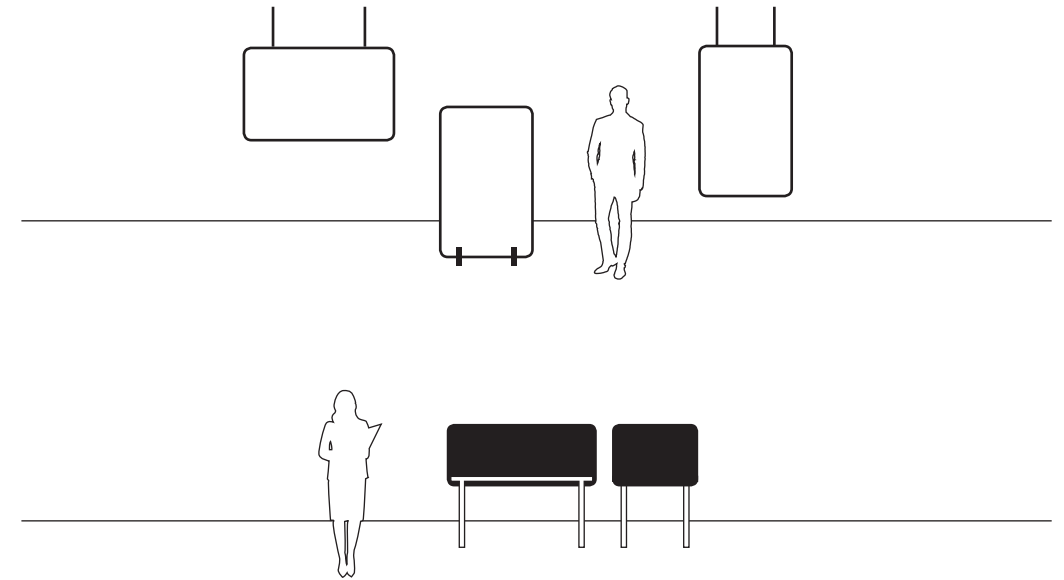

A - Wooden frame

B - Basotect® melamine foam or Polyurethane foam

C - Fabric

A - Duo 1000x1600mm
(Basotect foam)

B - Duo 1000x1600mm
(Polyurethane foam)

Duo screens are made of a solid wooden frame covered in fabric. Duo is available with two types of acoustic filling: Basotect melamine foam or an open-cell polyurethane foam. Attach it to your desk, hang it from the ceiling or use one of our four metal connectors to create free-standing structures.

Duo has been tested and certified in a professional reverberation chamber according to EN ISO 354. You can choose one of two types of acoustic filling depending on your sound absorption needs. Polyurethane foam offers very good, while Basotect foam offers extraordinary sound absorption results.

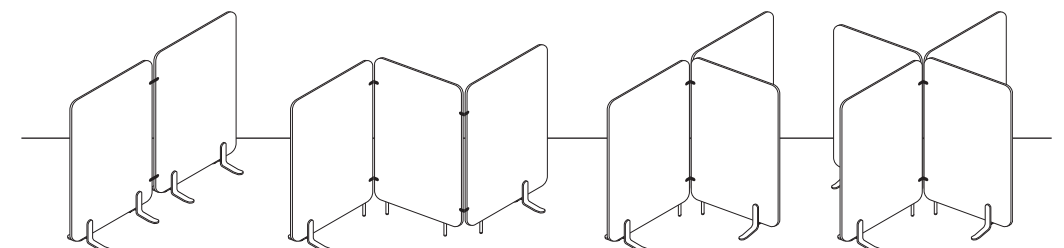



Connectors for standing screens

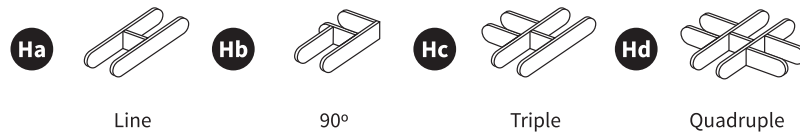

Systems **Ha, Hb, Hc, Hd** available in: white (1), black (2), silver (3).

Configurations of desk panels

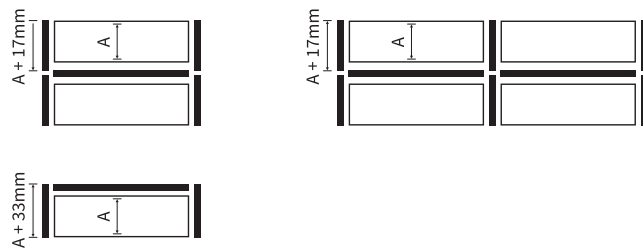

Thickness [mm] 33mm

Duo. Configure your product.

Choose your order specifics

HUSH

	01	02	03	04
Type	Desk	Standing	Hanging horizontal	Hanging vertical
Size W x H [mm]	600 x 500 650 617 x 500 650 633 x 500 650 800 x 500 650 817 x 500 650 833 x 500 650 1000 x 500 650 1200 x 500 650 1400 x 500 650 1600 x 500 650 1800 x 500 650 2000 x 500 650	600 x 1200 600 x 1400 600 x 1600 600 x 1800 800 x 1200 800 x 1400 800 x 1600 800 x 1800 1000 x 1200 1000 x 1400 1000 x 1600 1000 x 1800 1200 x 1200 1200 x 1400 1200 x 1600 1200 x 1800	1400 x 650 1600 x 650 1800 x 650 1400 x 800 1600 x 800 1800 x 800 1400 x 1000 1600 x 1000 1800 x 1000 1400 x 1200 1600 x 1200 1800 x 1200	650 x 1400 650 x 1600 650 x 1800 800 x 1400 800 x 1600 800 x 1800 1000 x 1400 1000 x 1600 1000 x 1800 1200 x 1400 1200 x 1600 1200 x 1800
		Height above desk: 500 mm		

Fixing system

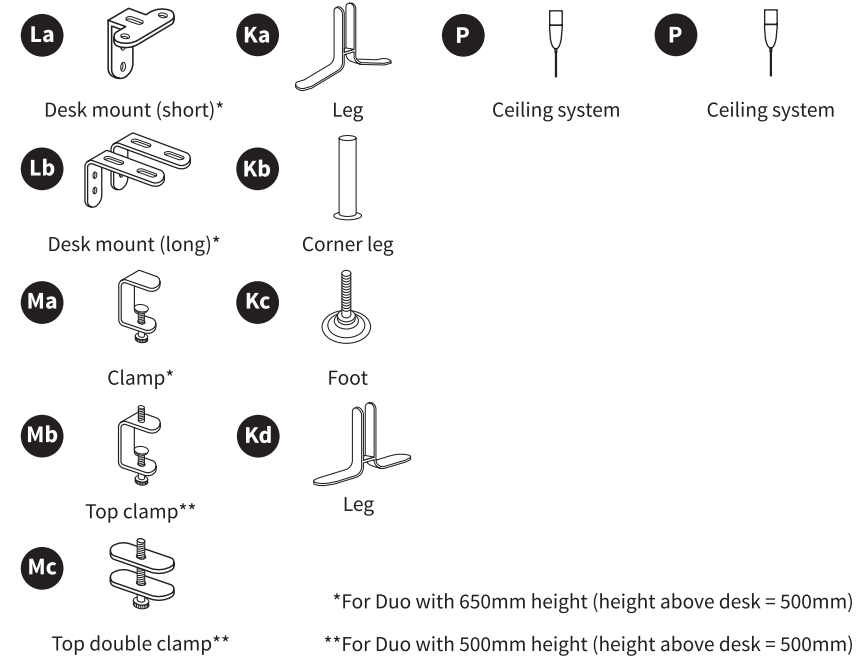

*For Duo with 650mm height (height above desk = 500mm)

**For Duo with 500mm height (height above desk = 500mm)

Systems **La, Lb, Ma, Mb, Mc, Ka, Kb** available in: white (1), black (2), silver (3). Systems **Kc** and **P** available in: silver.

Fabrics Available in all our standard fabrics (details on p. 46 or www.hushdesign.pl).

Order example DUO - 01 - 1200x650 - Lb2 - EV11

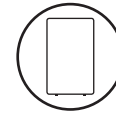
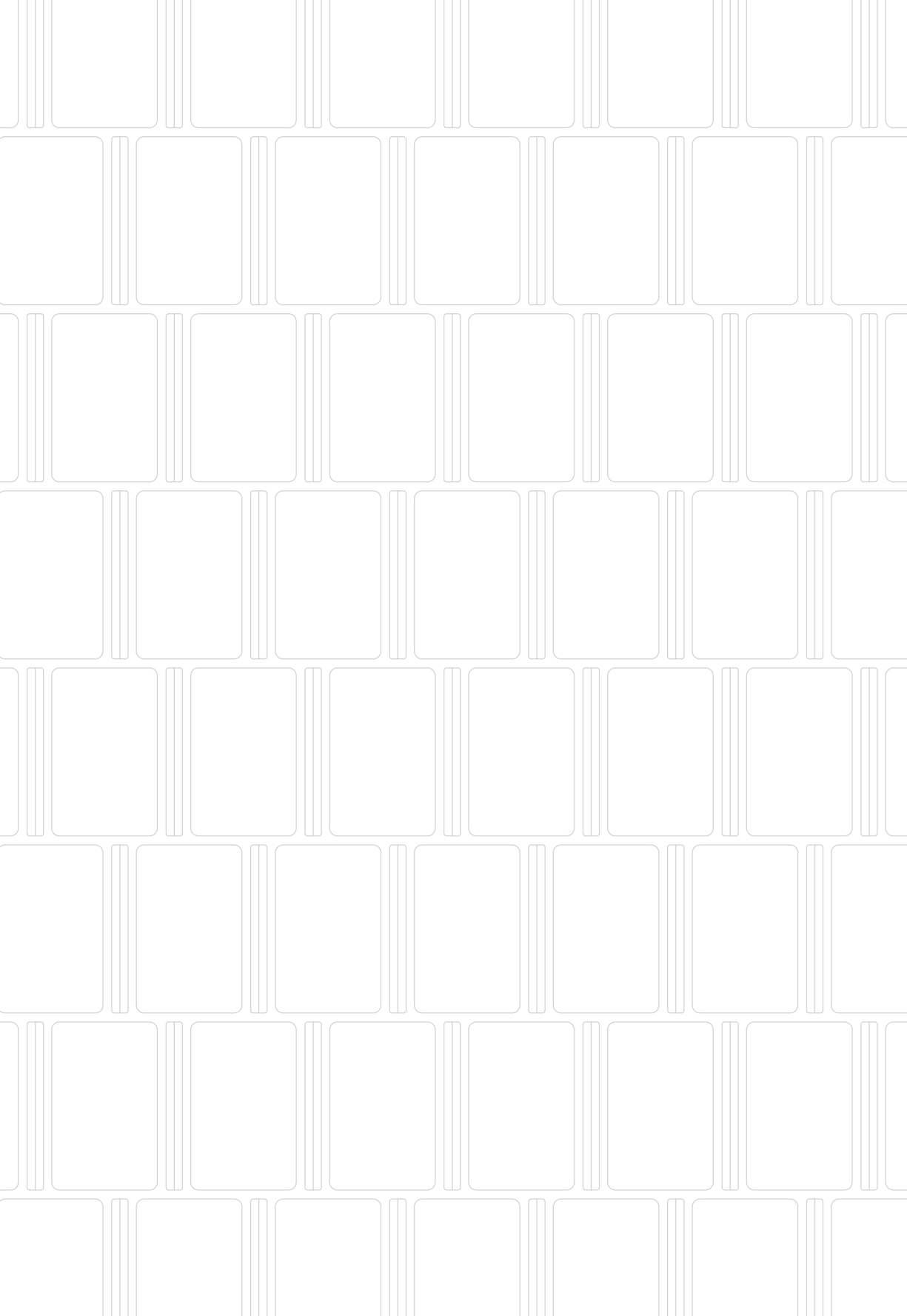

Standing
screens

Wall

Design **HUSH**



Wall is a free-standing screen merging extremely high sound attenuation and sound absorption properties. Its simple design makes it a good fit for all types

of open-space offices. Wall can be used as a single screen or as several screens put together with our metal connectors.



Universal solution for sound **absorption** and **attenuation**.

Example of Wall screens configurations

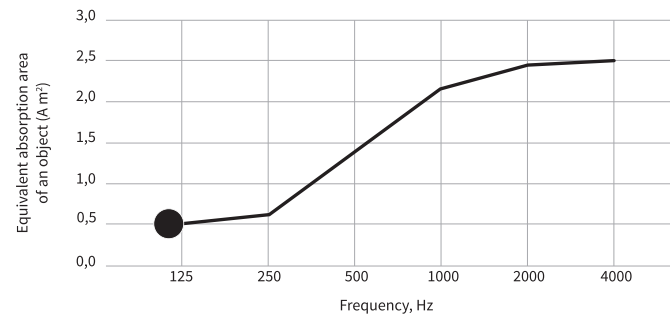
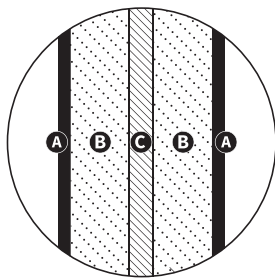
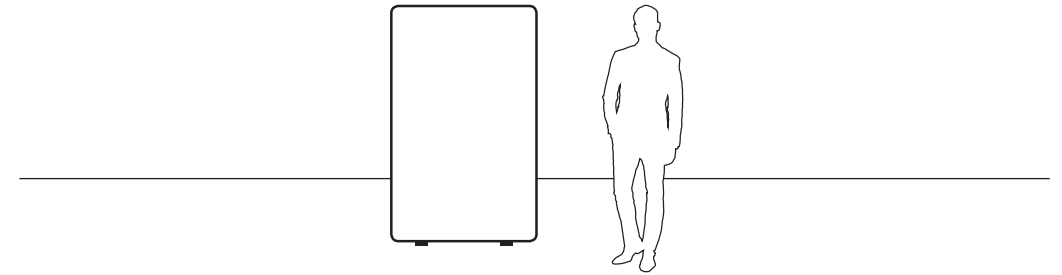

- A - Fabric
- B - Basotect® melamine foam
- C - MDF board partition

- - Wall 1000x1600mm (Basotect foam)

Wall is made of two layers of Basotect melamine foam glued on both sides of MDF board, closed in a wooden frame. Melamine foam is one of the best sound absorbers, whereas MDF board is responsible for high level of sound attenuation. The wooden frame upholstered in fabric gives the panels its perfect edges.

Wall's primary function, sound attenuation, has been certified according to EN ISO 10053. The results are extraordinary, with average sound attenuation of **15db**. On top of that, Wall is certified as a very good sound absorber according to EN ISO 354. Both results make it one of the best products on the market combining sound attenuation and sound absorption properties.

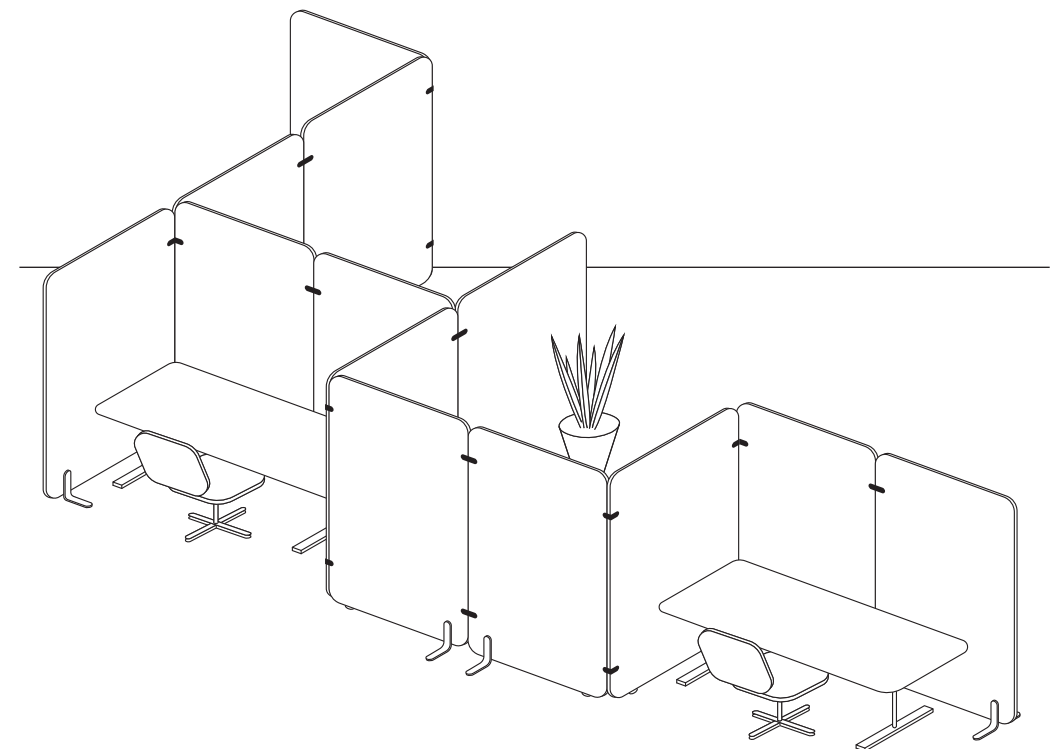



Wall. Configure your product.

Choose your order specifics

HUSH

Type

01

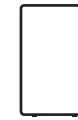

Standing

Size
W x H [mm]

600 x 1200/1400/1600/1800
625 x 1200/1400/1600/1800
650 x 1200/1400/1600/1800
700 x 1200/1400/1600/1800
725 x 1200/1400/1600/1800
750 x 1200/1400/1600/1800
800 x 1200/1400/1600/1800
825 x 1200/1400/1600/1800
850 x 1200/1400/1600/1800
1000 x 1200/1400/1600/1800
1200 x 1200/1400/1600/1800

Thickness [mm]

50mm

Fixing systems
and metal
connectors

Na



Leg

Nb



Foot

Oa



Line

Ob



90°

Oc



Triple

Od



Quadruple

Systems **Na**, **Oa**, **Ob**, **Oc**, **Od** available in: white (1), black (2), silver (3). **Nb** available in: silver.

Fabrics

Available in all our standard fabrics (details on p. 46 or www.hushdesign.pl).

Order example

WALL - 01 - 800x1600 - Na2 - SY6
WALL - 01 - 725x1400 - Nb - SN14

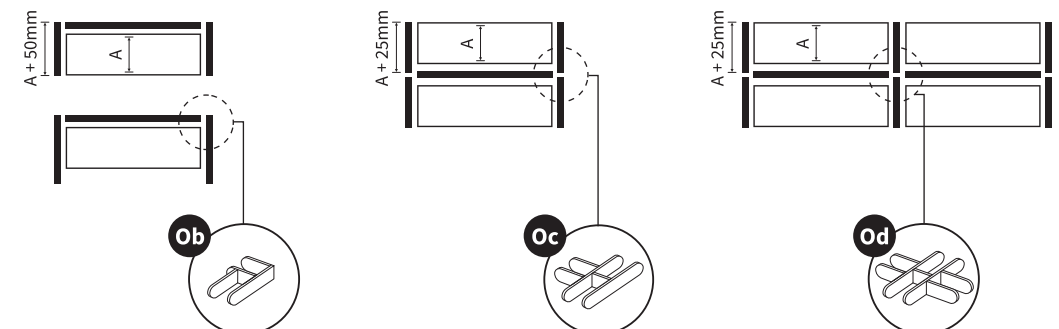

Call-center type of Wall configurations may require additional desk mounting systems for stability.

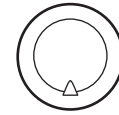

Standing
screens

Cone

Design **Jakub Sobiepanek**

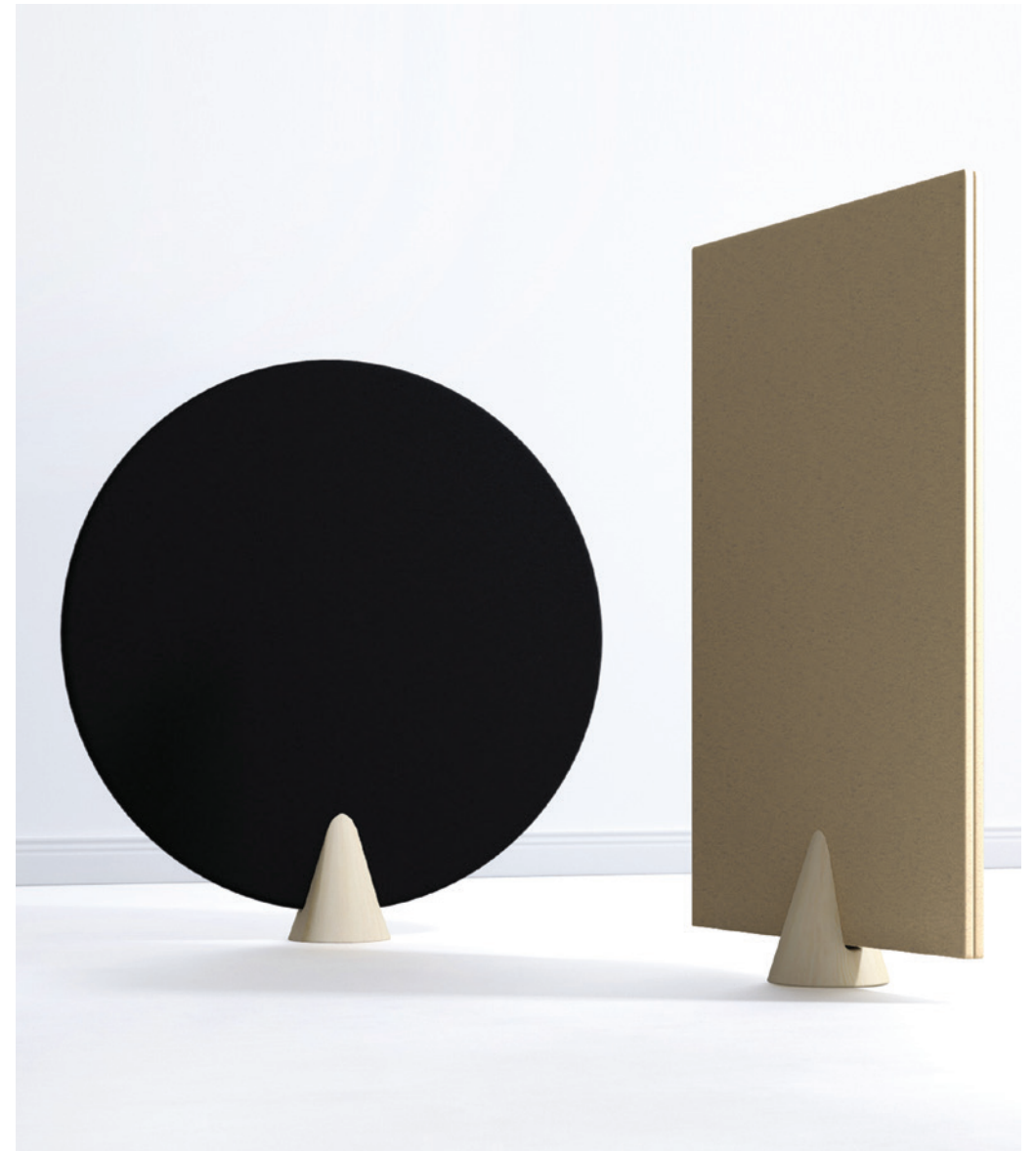
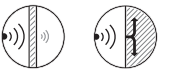

Cone is a great solution for sound absorption and sound attenuation with a designer's touch. This acoustic screen is available in two forms:

round and rectangle. Both shapes of the screen share the same type of wooden stand which will add character to any office, hotel or restaurant space.

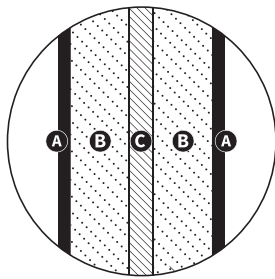





- A - Fabric
- B - Basotect® melamine foam
- C - MDF board partition

Cone consists of two layers of Basotect melamine foam, which gives the panel its high sound absorption properties, and an MDF board in the middle responsible for blocking unwanted noise. Thanks to its construction, Cone is relatively light for its acoustic properties.

Cone cannot be mistaken for any other product thanks to the original design of its wooden stand. It is a great addition to any open-space office, reception hall, coffee area or any other space where you would like to combine style with great acoustic properties.

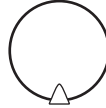
Cone. Configure your product.

Choose your order specifics

	01	02
Shape		
	Round	Rectangle
Size W x H [mm]	Ø 1200 Ø 1500	800 x 1600 1000 x 1600
Thickness [mm]	50mm	
Fixing systems	  Wooden stand	
Fabrics	Available in all our standard fabrics (details on p. 46 or www.hushdesign.pl). Cone Round 1500mm available only in Evo, Synergy 170 or any other fabric with min. 1700mm width on special request.	

Order example

CONE - 01 - 1500 - EV20
 CONE - 02 - 800x1600 - SY18

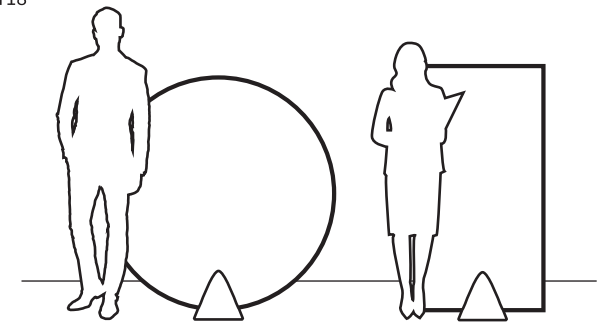

the art of silence

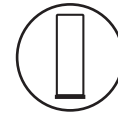
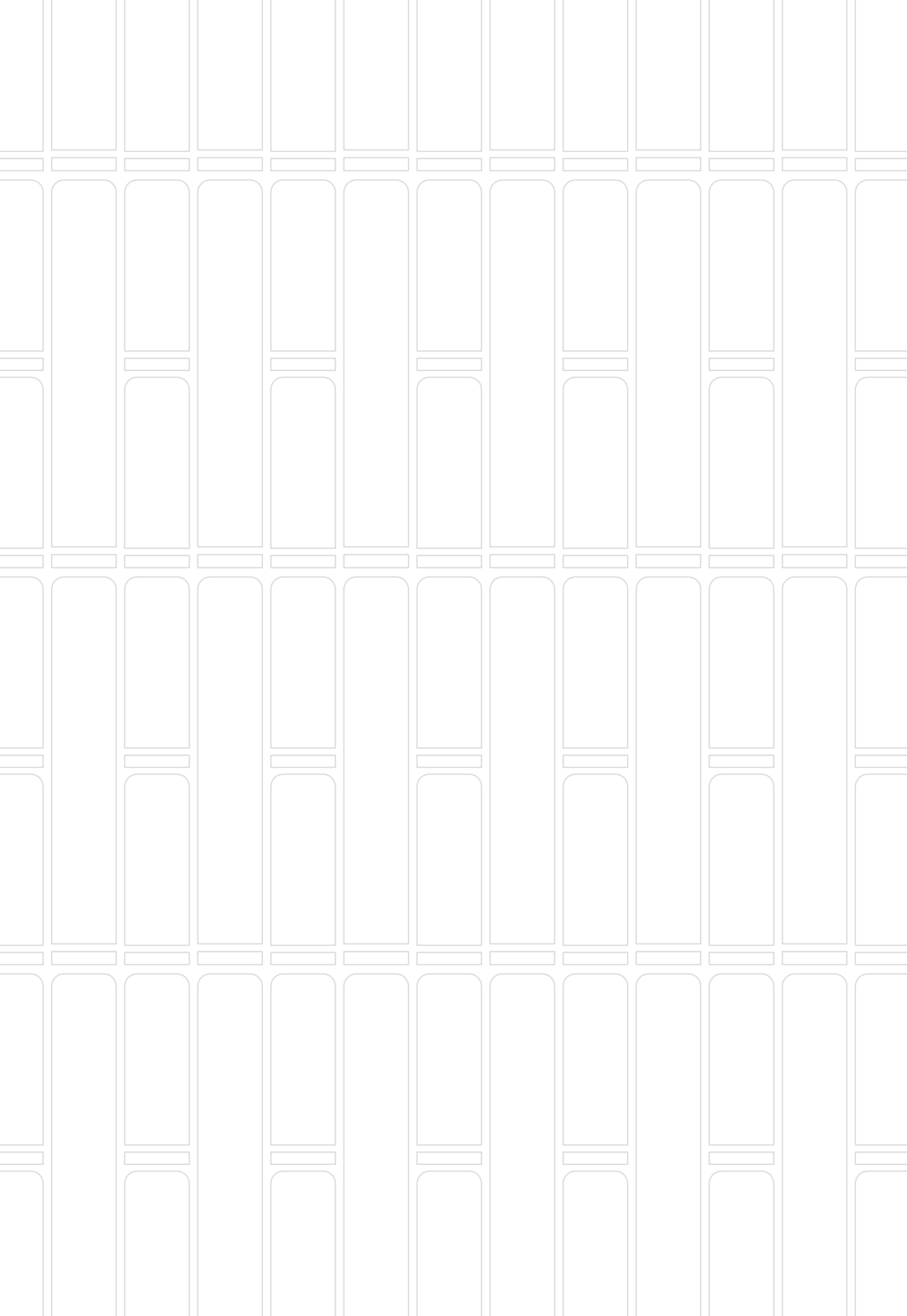

Standing column

Tower

Design **HUSH**



Tower is a highly effective free-standing acoustic absorber. Its acoustic properties allow you to reduce the number of other absorbers to achieve a balanced

acoustic environment. Tower is extremely light and easy to rearrange. Its „grandness” is a perfect design addition to any conference room or open-space office.

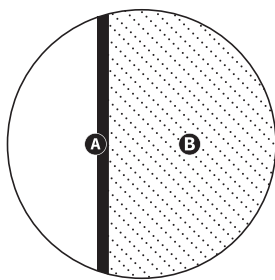

A - Fabric
B - Basotect® melamine foam

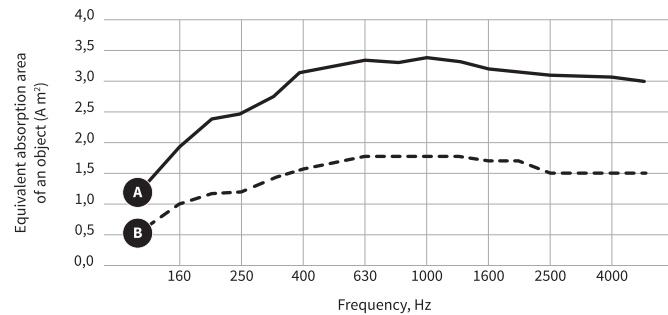

A - Tower 2m
 $a_w = 1.00$ (class A) **B** - Tower 1m
 $a_w = 1.00$ (class A)

Tower has a simple, yet ingenious construction. It's made from a specialistic melamine foam, upholstered in fabric of your choice. To enhance stability and protect from damage, it has a stand in lightweight aluminium.

Thanks to a very high accumulation of sound absorbing material, Tower has unprecedented sound absorbing results. It is certified as class A absorber. Use it on its own or combine it with HUSH wall or ceiling panels to create a pleasant acoustic environment in any room.

Tower. Configure your product.

Choose your order specifics

HUSH

Shape	01	02
Size W x D x H [mm]	360 x 360 x 2000	360 x 360 x 1000
Stand	Thin stand in lightweight aluminium protecting the product from damage. Stand available in white (S1), black (S2), silver (S3).	
Fabrics	Available in Evo, Sprint, Synergy 170 (details on p. 46 or www.hushdesign.pl). Other fabrics with min. 1500mm width available on special request.	

Order example

TOWER - 01 - S2 - SN15
TOWER - 02 - S3 - EV14

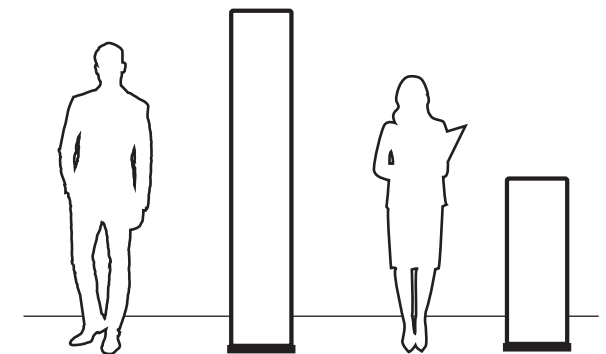

the art of silence

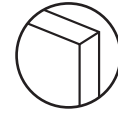
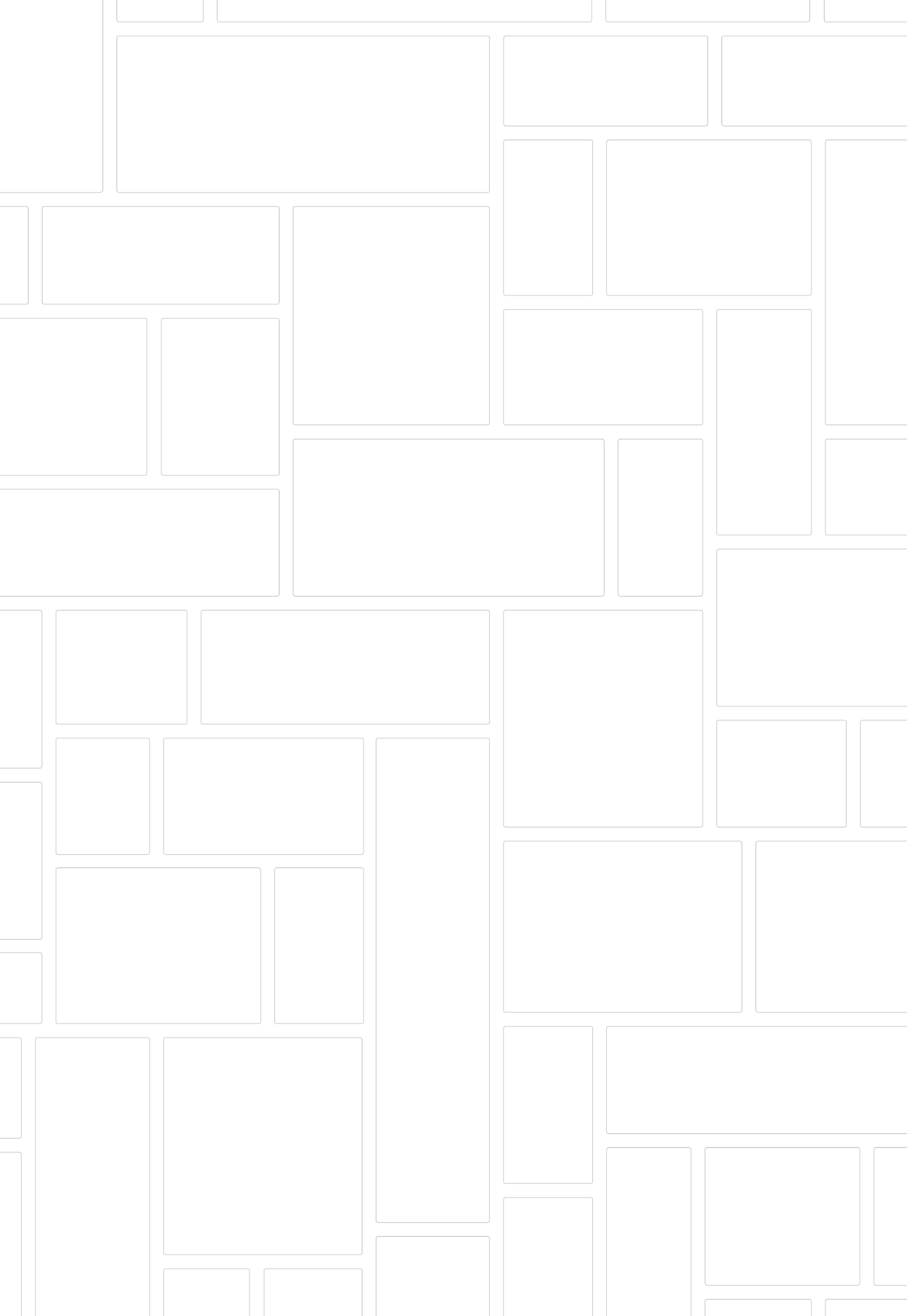

Wall panels

Print

Design **HUSH**



Print is a wall acoustic panel with a personalized image printed on fabric. Now you can both improve acoustic comfort and decorate your

conference room, canteen or reception hall with a printed image of your choice.

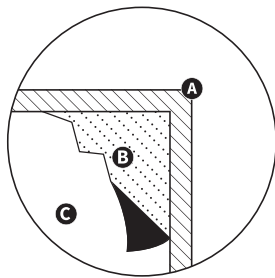

- A** - Aluminium profile
- B** - Basotect® melamine foam
- C** - Customized print on fabric

Print is made of a carefully selected melamine foam, which has outstanding sound absorbing properties. The foam is inserted into an aluminium profile and covered with an image of your choice, printed on a thin fabric.

Print's durable aluminium frame has been designed specifically for HUSH. It allows you to replace the fabric on the panel without taking it off the wall. Choose your image and size of our Print panel to decrease reverberation time in your room.

Print. Configure your product.

Choose your order specifics

HUSH

01

Shape



Size
W x H [mm]

max. 2200mm x max. 3000mm

Thickness [mm]

53mm

Fixing systems

U



Metal rail for wall mouting

Fabrics

White fabric with personalized image printed on it.

Order example

PRINT - 01 - 600x1800 - U
PRINT - 01 - 2000x2500 - U

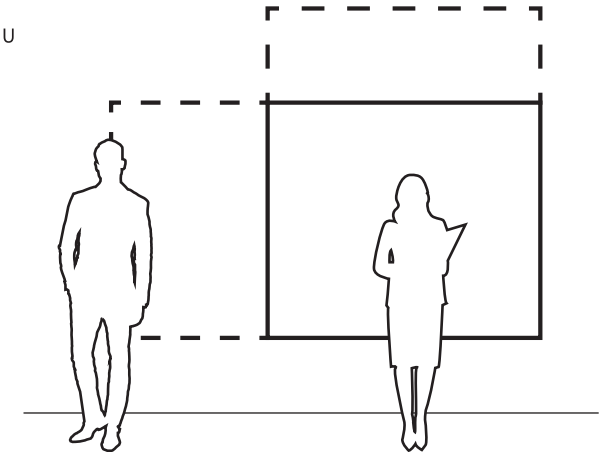

the art of silence

Standard Fabrics

Price Group 1 **EVO**

Weight: 300g/m²
Composition: 100% Polyester
Flammability: BS EN 1021-1 / BS EN 1021-2



Price Group 2 **SPRINT** by Camira

Weight: 328g/m²
Composition: 100% Polyester
Flammability: BS EN 1021-1 / BS EN 1021-2

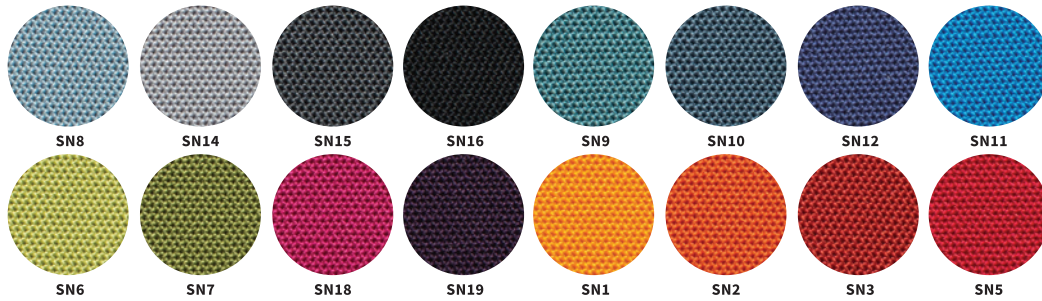

Price Group 2 **XTREME** by Camira

Weight: 310g/m²
Composition: 100% Recycled Polyester
Flammability: DIN4102-1 B1

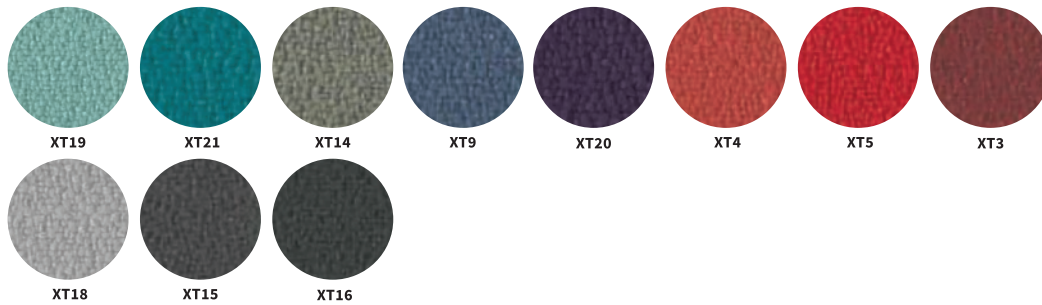

Price Group 2 **MEDLEY** by Gabriel

Weight: 364g/m²
Composition: 100% Polyester
Flammability: BS EN 1021-1 / BS EN 1021-2

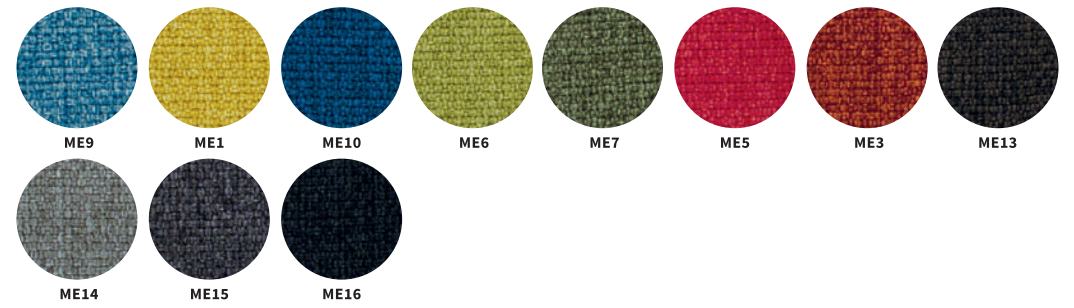

Price Group 3 **SYNERGY** by Camira

Weight: 400g/m²
Composition: 95% Wool, 5% polyamide
Flammability: PN EN 1021-1 / PN EN 1021-2

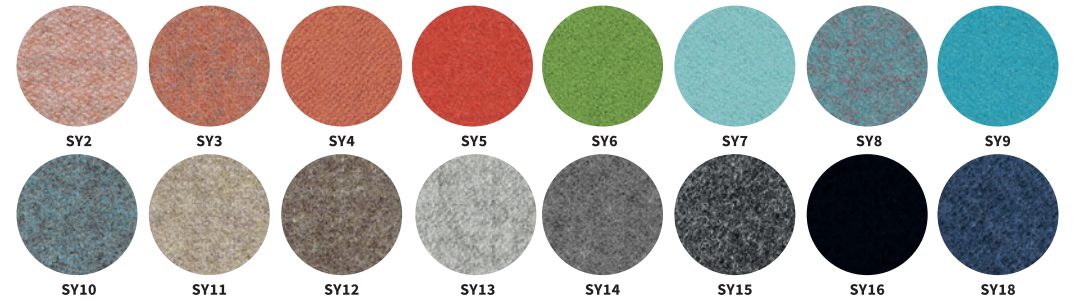

Price Group 3 **SYNERGY 170** by Camira

Weight: 400g/m²
Composition: 95% Wool, 5% polyamide
Flammability: PN EN 1021-1 / PN EN 1021-2

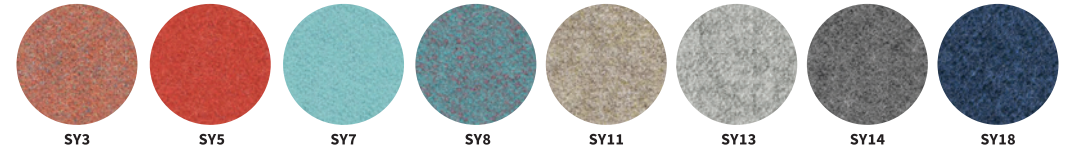

Synergy 170 fabric is intended only for products: Tower and Cone 01 1500mm.
Lead time in Synergy 170 may be longer than our standard lead times.

Colors presented in the catalogue may vary from the original colors of fabrics.

Fixing systems

Blocks

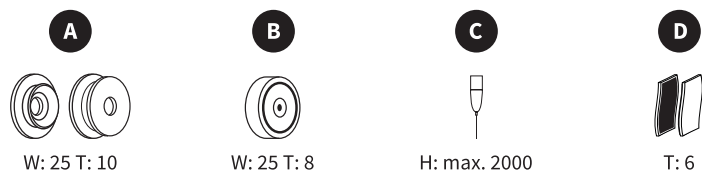

W: 25 T: 10

W: 25 T: 8

H: max. 2000

T: 6

Puzzle

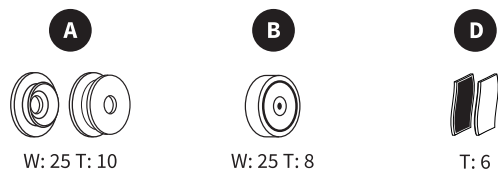

W: 25 T: 10

W: 25 T: 8

T: 6

Duo

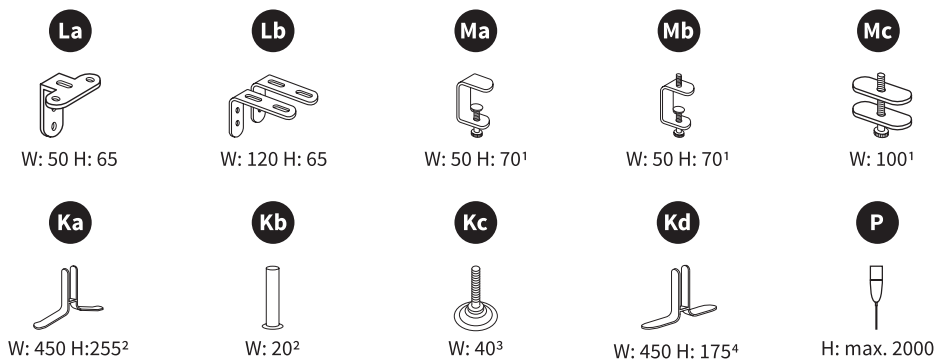

W: 50 H: 65

W: 120 H: 65

W: 50 H: 70¹

W: 50 H: 70¹

W: 100¹

W: 450 H: 255²

W: 20²

W: 40³

W: 450 H: 175⁴

H: max. 2000

- ¹ max. tabletop thickness = 50mm
² panel mounted 90mm above floor
³ panel mounted 10-30mm above floor

Wall



W: 450 H: 175⁴

W: 40⁵

- ⁴ panel mounted 15mm above floor
⁵ panel mounted 10-30mm above floor

Cone



W: 300 H: 300⁶

- ⁶ panel mounted 65mm above floor

W - width
H - height
T - thickness / distance from wall

All measures in mm.

